

CATALOGUE



**Complete range of products and systems
for fire alarm installations**

www.sd3.fr



A world of fire detection equipment

SD³ : A WORLD OF FIRE DETECTION EQUIPMENT

Our company

SD³ is specialized in sales, marketing, training and technical support of fire alarm products manufactured by our French panels and detectors' factories.

Experience and world expansion

We are part of the first French manufacturer of fire alarm systems and fire protection solutions in France with more than 60 years of experience. SD³ is dedicated to collaborate with a network of partners all over the world.

A French label and certifications

Our «made in France» label, experience, certifications and the wide range of quality products make of us your ideal partner.

Diversified products for different application areas and installation

Our variety of products allows you to offer systems from the basic installation to the most advanced ones.

It also enables you to supply products in different fields of application : Hotels, buildings, shopping mall etc...as well as in the industrial one like nuclear power stations, specific storages, oil and gas environment etc...

Customization

We offer you the possibility to label our main products with your brand which will allow to expand our presence in new markets and build stronger partnerships.

We look forward to a fruitful partnership.

Bernard Mongelli

Director





CONVENTIONAL SYSTEMS	6-17
Panels	8
Fire detectors	12
Manual call points	13
Air duct detection	14
Digital linear heat detection	14
Stand alone detectors	15
Gas alarm detectors	15
CONVENTIONAL GENERAL VIEW	16-17
INTELLIGENT / INTERACTIVE PANELS AND DETECTORS / DEVICES	18-31
Panels	20
Intelligent Fire Detectors	26
Addressable Manual Call Points	28
Loop Sounders	28
Interface Loop Units	29
Programming and Maintenance Tool	29
ADDRESSABLE GENERAL VIEW	30-31
SPECIAL PRODUCTS	32-53
LINEAR SMOKE DETECTORS	34
WIRELESS SOLUTIONS	35
AIR SAMPLING DETECTION	36-37
GAS DETECTION	38-39
EXPLOSION PROOF GAS DETECTION	40
DEVICES FOR FIRE EVACUATION	41
MONITORING SOFTWARE	42-43
EXPLOSION HAZARD AREA FIRE DETECTION	44-45
EXTINGUISHING SYSTEMS	46
MARINE	47-48
ACCESSORIES FOR FIRE ALARM SYSTEM	49
HEPHEA RANGE POWER SUPPLY	49
VOICE EVACUATION SYSTEMS	50-51
ELECTRIC LOCK FOR EMERGENCY EXIT DOORS	51
FIRE ALARM CABLE	52
MAINTENANCE AND TEST EQUIPMENT	52-53



SD³ represents the export department of these factories all over the world.

Location : Massy (Paris) FRANCE



Detectors, Call points, Modules

Location: Dadonville FRANCE

Created in 1989, FARE is specialised in developing and manufacturing conventional and addressable detectors.

FARE CERTIFICATIONS :

ISO / AFNOR / BOSEC-ANPI / CPD/CPR by notified body



Conventional and Intelligent/Addressable panels

Location: Dadonville FRANCE

SEFI was founded in 1970. The company manufactures conventional and addressable fire alarm panels and auxiliaries.

SEFI CERTIFICATIONS :

ISO / AFNOR / BOSEC-ANPI / CPD/CPR by notified body



Sounders and flashes

Location: Massy (Paris) FRANCE

SESSY CERTIFICATIONS :

AFNOR / BOSEC-ANPI / CPD/CPR by notified body



Gas detectors and panels, Power supply

Location: Verona ITALY

DELTA ERRE CERTIFICATIONS :

ISO / AFNOR / BOSEC-ANPI / CPD/CPR by notified body



Voice evacuation, public address

Location: Montauban FRANCE

BOUYER CERTIFICATIONS :

ISO / AFNOR



Extinguishing system

Location: Paris FRANCE

EXTINCTIUM CERTIFICATIONS :

ISO / AFNOR



Stand alone detector

Location: Pithivier FRANCE

SHD CERTIFICATIONS :

ISO / AFNOR



0333

Certificate of conformity
 Issued in conformity with the transposition decree number 92-647 of 8 July 1992, modified by the
 September 1995 and the decree number 2003-647 of 3 October 2003 concerning appropriate use
 conformity with article 14 (1) (b) of the Construction Products Directive (89/106/EEC), of 21 Decembr
 93/68/EEC of 22 July 1993.

Delivered by:	AFNOR Certification
Notified Body:	0333
Identification number:	11 rue Franca de Pressensé
Address:	FR - 93571 LA PLAINE SAINT-DENIS CEDEX
Delivered to:	FARE
Company:	ZA de la Guinette
Address:	rue Duhamel de Monceau 45300 DADONVILLE - France
Manufacturing site:	Dadonville - France

Product: **Optical smoke detector with input / output d**

Detailed description of product: Annex

The product mentioned in annex is the object by the manufacturer of a factor
 of manufacture in accordance with a pre-established test plan.
 AFNOR Certification carried out tests of the initial type on the product, it
 factory and carries out a continuous surveillance, evaluation and an accor
 This certificate attests that provisions concerning the attestation of cor
 and that the product fulfills all the requirements demanded by
 being within the EEA:

Product: Smoke detector
 Sounders
 133

g - Granbonpré 1
 BE - BELGIUM
 Fax: 32 2 234 36 17

Email : cert@anfpl.be



First French fire alarm manufacturer

CONFORMITY

041

European Communities of 21 December 1988 on the
 the Member States relating to the construction products
 of the Council of European Communities of 22

ing Equipment
ontrol and Delay Device
l Class A
A 4/8/12
FP 612
 (for 1 flooding zone)
Supply Equipment

Detection and Fire alarm Systems
 onents for gas extinguishing systems
 the market by

S. S.E.F.I.
 Rue Duhamel du Monceau
 ainvilliers - BP 90817
 DADONVILLE
 FRANCE

uced in the factory
 S. S.E.F.I.
 Rue Duhamel du Mon
 illiers - BP 90817
 VILLE



Commercial relationship



Technical trainings Assistance



ion under
ries brand
the world







CONVENTIONAL SYSTEMS	6-15
Panels	8
Fire detectors	10
Manual call points	11
Air duct detection	12
Digital linear heat detection	12
Stand alone detectors	13
Gas alarm detectors.....	13
CONVENTIONAL GENERAL VIEW.....	14-15



CONVENTIONAL SYSTEMS

PANELS

From 4 up to 12 zones

ALPHA 4/8/12

12 ZONES FIRE DETECTION CONVENTIONAL PANEL equipped with 4 zones (max 12 zones) - max 32 detectors and/or MCP per line.

- Alarm/fault relays,
1 monitored sounders line,
4 programmable open collectors,
1 programmable input.

- Alarm prealarm/management + Day night mode. Expandable panel with availability of 2 rooms for one or two 4 zones expansion board (EX4A4) or one or two Extinguishing boards (DEAG).

- EN54-2, EN54-4, EN54-13 AFNOR, BOSEC, CE CPD/CPR, EN12094-1 with extinguishing board (DEAG).

- Needs 2 batteries 12V/7Ah
Exists also in 110VAC version



With fire brigade key

ALPHA 4/8/12 FBKEY

12 ZONES FIRE DETECTION CONVENTIONAL PANEL equipped with 4 zones (max 12 zones) - INCLUDING INTEGRATED FIRE BRIGADE KEY PROCESS (Action of key disable all function buttons). - Max 32 detectors and/or MCP per line.

- Alarm/fault relays,
1 monitored sounders line, 4 programmable open collectors, 1 programmable input.

- Alarm prealarm/management + Day night mode. - Expandable panel with availability of 2 rooms for one or two 4 zones expansion board (EX4A4) or one or two Extinguishing boards (DEAG).

- EN54-2, EN54-4 AFNOR, BOSEC, CE CPD, EN12094-1 with extinguishing board (DEAG). Needs 2 batteries 12V/7Ah



Options

Expansion zone

EX4A4

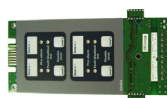

4 ZONES EXPANSION BOARD, max 32 detectors and/or MCP per line, 1 or 2 EX4A4 boards can be plugged in ALPHA 4/8/12 and permits to expand the panel to 8 (with 1xEX4A4) or to 12 zones (with 2xEX4A4)

Relay Card

REP4R



4 WAYS RELAY CARD, NO-NC 30V/1A, to be plugged inside the panel, connection by wires with programmable open collectors of ALPHA 4/8/12

R12P2



12 WAYS RELAY CARD, NO-NC 30V/1A, to be plugged inside ALPHA 4/8/12 panel, serial communication, permits to repeat states of the panel on 12 relays

REP4MO



4 SEPARATED MONITORED WAYS SOUNDER CIRCUIT extension board, permits to have 4 monitored sounder circuits. To be plugged inside the panel

Flushmounting

ALP24-KIT19



FLUSH MOUNTING METALLIC FRAME and backbox for ALPHA 4/8/12 or HEPHAIS 128

Accessories

TR-SDI

REMOTE INDICATOR PANEL with leds and function keys, to repeat general alarm and fault, local test leds and silence buzzer





CONVENTIONAL SYSTEMS

ALPHA 4/8/12 : 4, 8 or 12 CONVENTIONAL ZONES PANEL

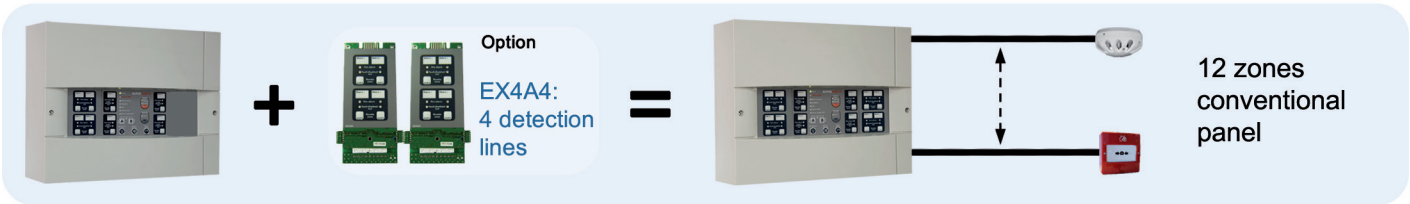
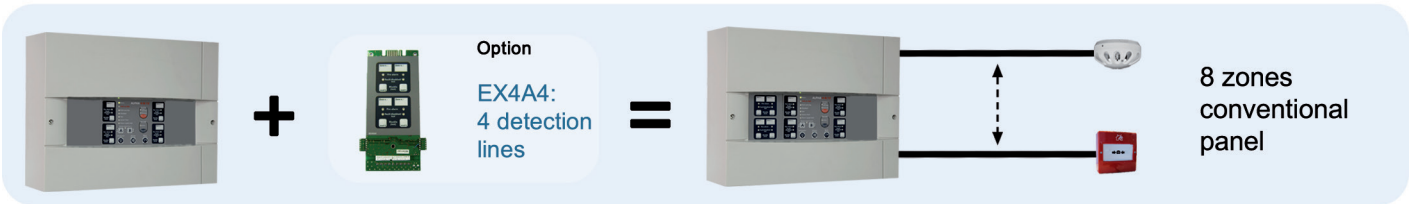
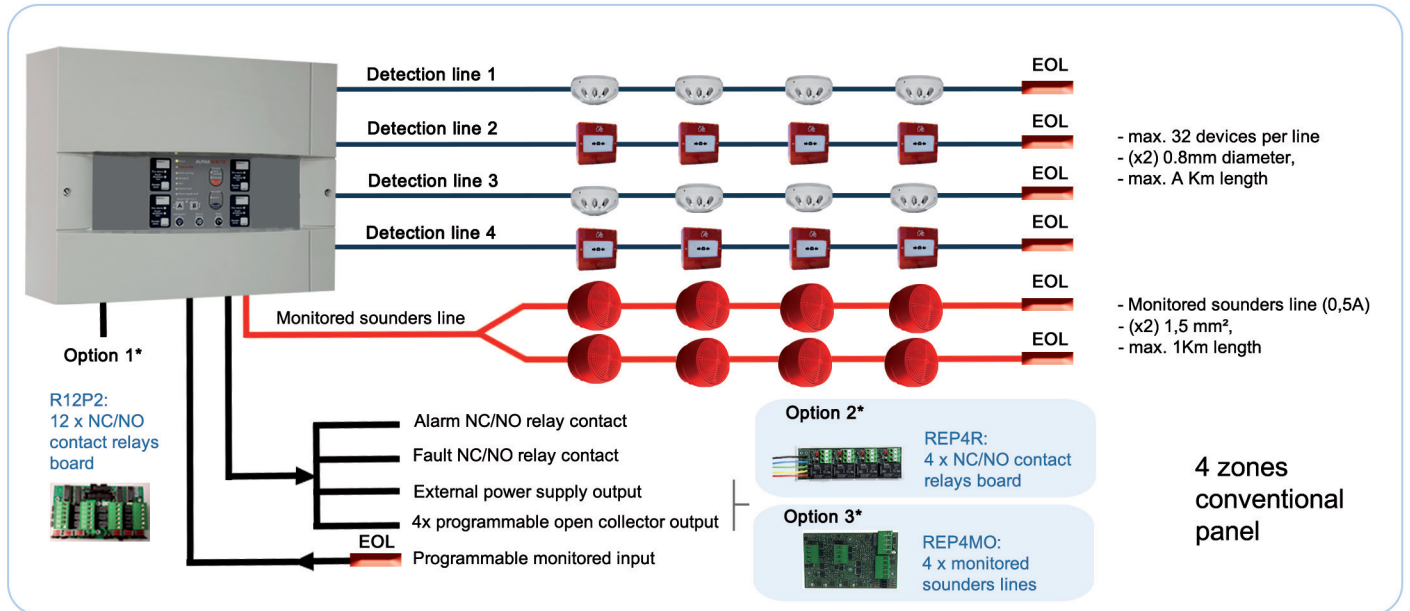

*Note: The panel support one option only.



CONVENTIONAL SYSTEMS

FIRE DETECTORS

05 range



OC05

CONVENTIONAL OPTICAL SMOKE DETECTOR, 1 remote led output, EN54-7, CE according to CPD/CPR



TRC05

CONVENTIONAL RATE OF RISE + FIXED HEAT DETECTOR, T° = 62°C, + 9°C/min, 1 remote led output, EN54-5, CE according to CPD/CPR



TSC05-A1S

CONVENTIONAL FIXED HEAT DETECTOR, T° = 62°C, 1 remote led output, EN54-5, CE according to CPD/CPR



TSC05-BS

CONVENTIONAL FIXED HEAT DETECTOR, T° = 75°C, 1 remote led output, EN54-5, CE according to CPD/CPR

12Vdc application with 05 range



OC05.12 or OC05.12-AR

CONVENTIONAL OPTICAL SMOKE DETECTOR, for 12V security type systems, to be used with R05 relay board, alarm latched or autoresettable (AR version)



TRC05.12 or TRC05.12-AR

CONVENTIONAL RATE OF RISE + FIXED HEAT DETECTOR, T° = 62°C, + 9°C/min, for 12V security type systems, to be used with R05 relay board, alarm latched or autoresettable (AR version)



TSC05-A1S.12 or TSC05-A1S.12-AR

CONVENTIONAL FIXED HEAT DETECTOR, T° = 62°C, for 12V security type systems, to be used with R05 relay board, alarm latched or autoresettable (AR version)



TSC05-BS.12 or TSC05-BS.12-AR

CONVENTIONAL FIXED HEAT DETECTOR, T° = 75°C, for 12V security type systems, to be used with R05 relay board, alarm latched or autoresettable (AR version)

Bases and accessories



S05SE

UNIVERSAL BASE WITH STICK ADDRESS SOCKET for 05-range conventional and addressable detectors



PES05

FLUSHMOUNTING PIECE FOR BASE (Base not included), permits to flushmount a 05 range detector



SOUND05+S05SE

BASE WITH INTERNAL SOUNDER 95db @ 1m, Possibility to select 6 tones and 3 intensivity levels, EN54-3, CE according to CPD/CPR



R05

RELAY BOARD (12V or 24V) for 05 detectors (to be plugged in S05), NO-NC 30V/1A



CS05

PROTECTION PLATE for S05 base, permits to cover a base without detector



BRI/EM + S05SE

Universal base with GLANDS HOLE for 05 range, base for tubes connections



BRI+S05SE

WATERPROOF universal base with glands for 05 range (IP65), base for tubes connections supplied with glands



GAV

ANTIVANDALISM protection grid



CONVENTIONAL SYSTEMS

FLAME DETECTORS



IRY2 + S95

CONVENTIONAL INFRARED FLAME DETECTOR, 1 remote led output, vision cone $\pm 45^\circ$, Distance max 25m, EN54-10 class 1 and 2, CE according to CPD/CPR, base included



IRY2-IP65

CONVENTIONAL INFRARED FLAME DETECTOR, 1 remote led output, vision cone $\pm 45^\circ$, Distance max 25m, IP65 box, dim 225x175x80, CE according to CPD/CPR

MANUAL CALL POINTS

05 range



DMCL05

CONVENTIONAL MANUAL CALL POINT resettable with key without breaking glass, led and alarm resistor integrated, RED colour, EN54-11, CE according to CPD



DMCL05-J

CONVENTIONAL MANUAL CALL POINT resettable with key without breaking glass, led and alarm resistor integrated, YELLOW colour



DMCL05-B

CONVENTIONAL MANUAL CALL POINT resettable with key without breaking glass, led and alarm resistor integrated, BLUE colour

Accessories



PEDM

PLASTIC FRAME for flush mounting MCP



VPDM

TRANSPARENT LIFT-UP protective cover for MCP, permits a double action (supplied with protection label)



KCTDM

KIT OF 10 RESET KEYS for 05 MCP

05 waterproof MCP



DMC05 E

CONVENTIONAL **WATERPROOF** MANUAL CALL POINT resettable with key without breaking glass, led and alarm resistor integrated, RED colour, EN54-11, CE according to CPD/CPR



CONVENTIONAL SYSTEMS

AIR DUCT DETECTION



BTG05-P5901

AIR DUCT DETECTOR HOUSING for 05 range (optical detector not included), dimensions 220x186x105mm, IP55

DIGITAL LINEAR HEAT DETECTION

HC68



LINEAR HEAT DETECTION cable 68° (price per meter) connectable directly to conventional panels or addressable modules

HC105



LINEAR HEAT DETECTION cable 105° (price per meter) connectable directly to conventional panels or addressable modules

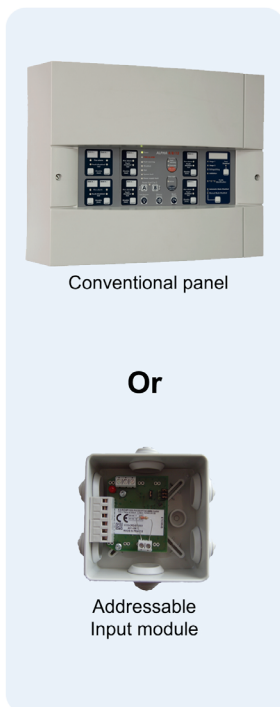

Conventional panel

Or

Addressable Input module

Alarm Resistor
RAL

HC68 or HC105
Max. length = 750m

EoL



CONVENTIONAL SYSTEMS

STAND ALONE DETECTORS

SMOKE ALARM DETECTOR



DOF49

DOMESTIC PHOTOELECTRIC SMOKE ALARM DETECTOR with 9V battery, 5 years life duration, 6 years warranty, CE EN14604 according to CPD (Exists also with lithium battery 9Vdc 10 years life duration)



VESTA

DOMESTIC PHOTOELECTRIC SMOKE ALARM DETECTOR with 9V battery, 5 years life duration, 6 years warranty, CE EN14604 according to CPD (Exists also with lithium battery 9vdc 10 years life duration). Dedicated for wireless application (wireless module not included)

Accessories for VESTA



DAAF-REL

PLUG IN CARD with NO contact, permits to repeat the state of alarm (for intrusion panels)

GAS ALARM DETECTOR



DAACO10

Stand alone CARBON MONOXIDE (CO) gas detector with electrochemical sensor, embedded buzzer. Supplied with 5 years life duration battery. CE CPD EN50291 conform



Defective or badly installed gas heater devices



Motor gas



Combustion in a closed area or badly ventilated



CONVENTIONAL GENERAL VIEW



ALPHA 4/8/12

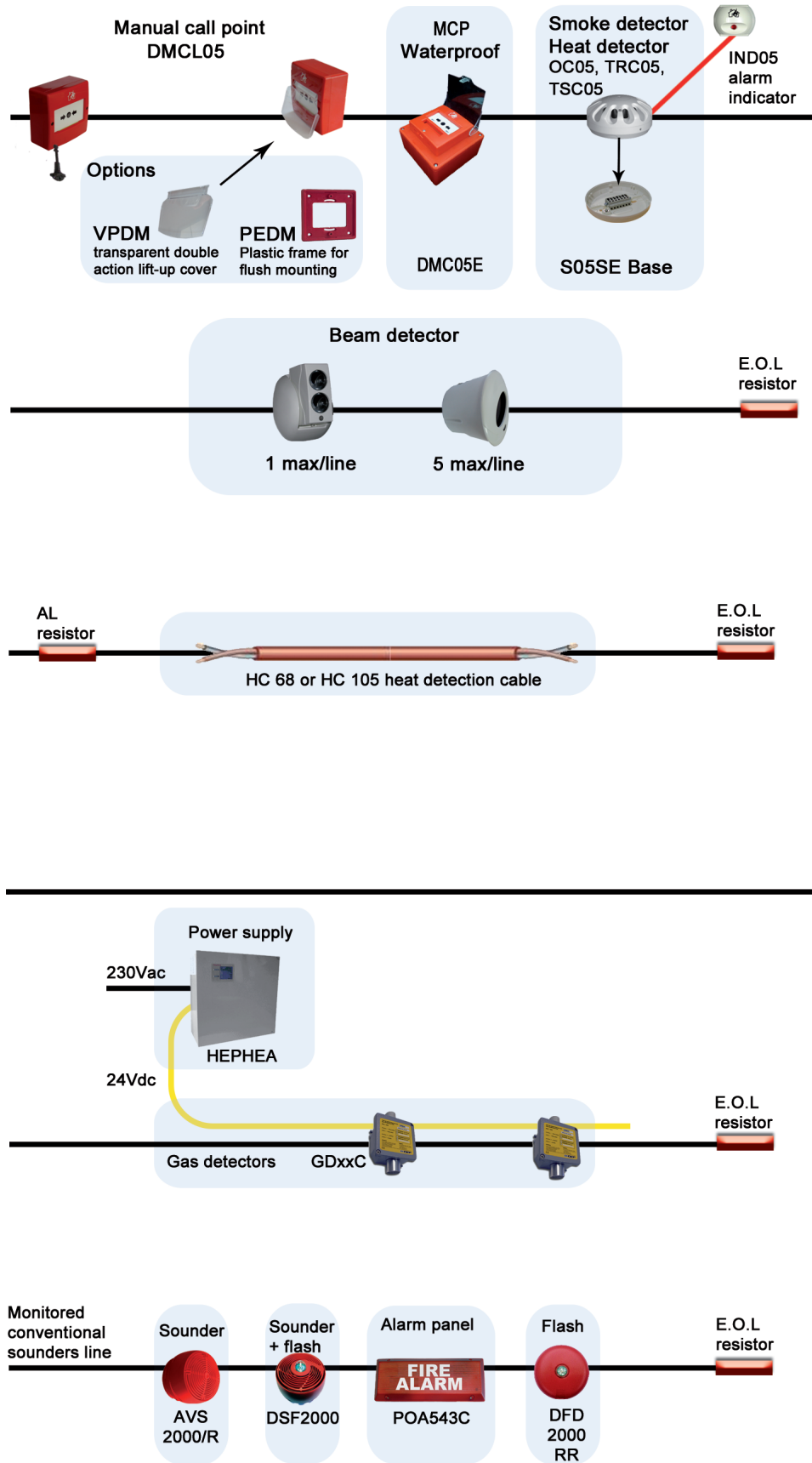



CONVENTIONAL GENERAL VIEW

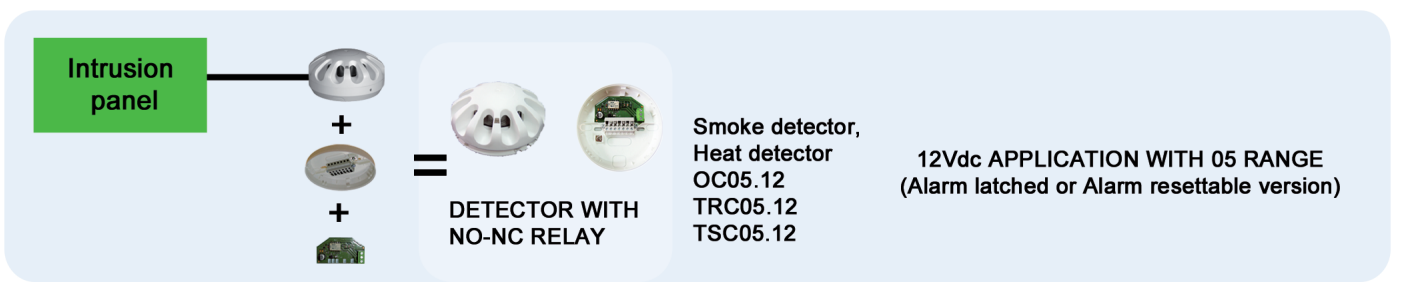
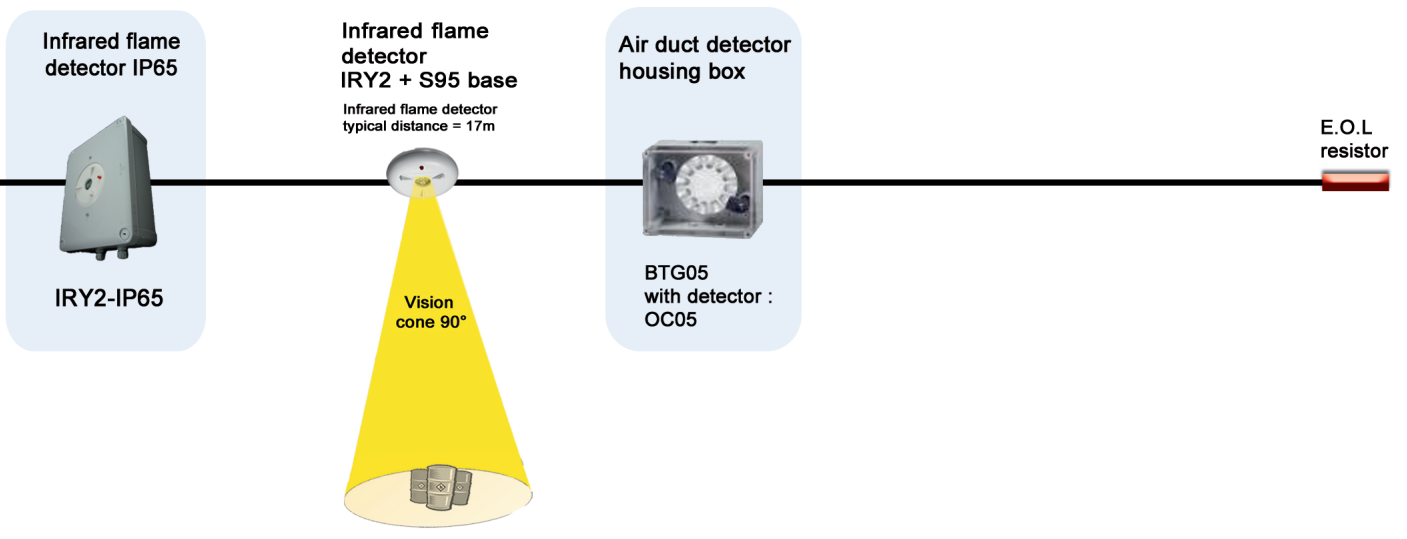
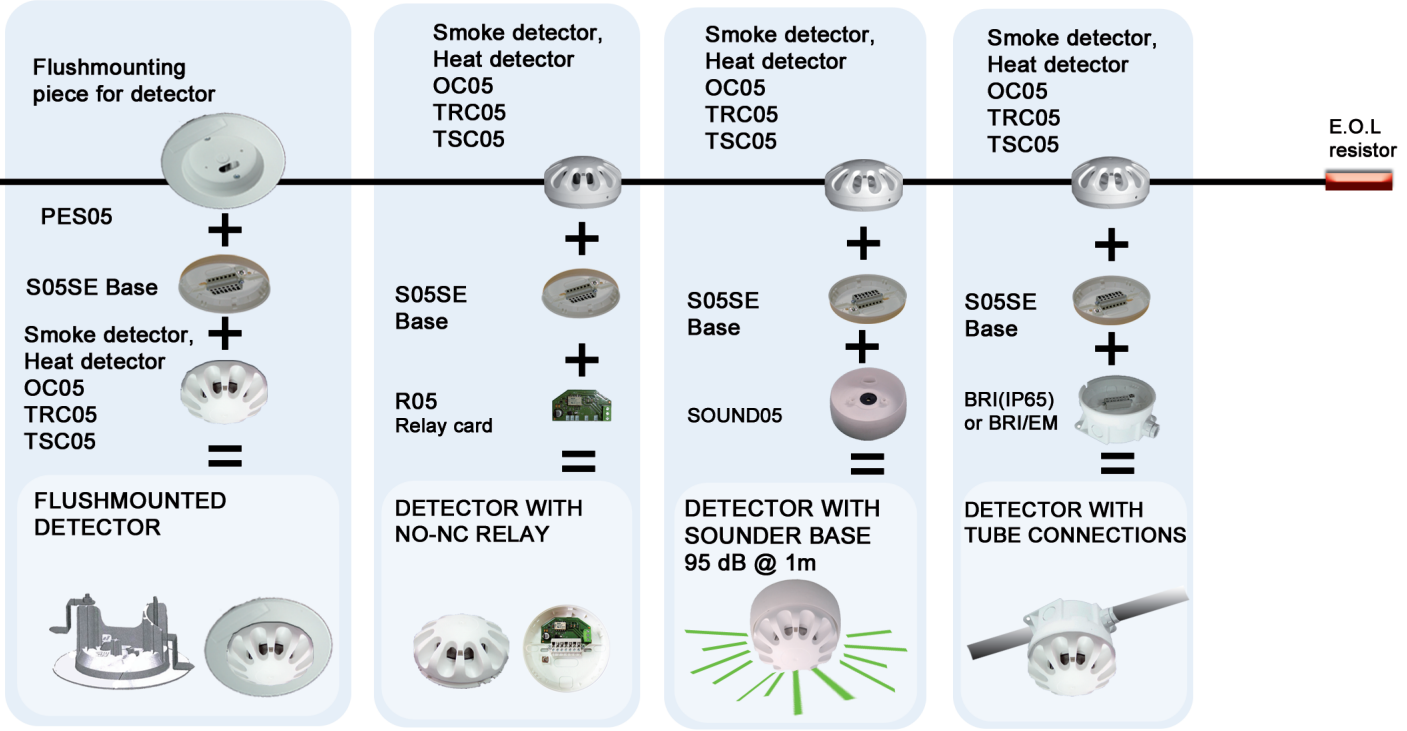

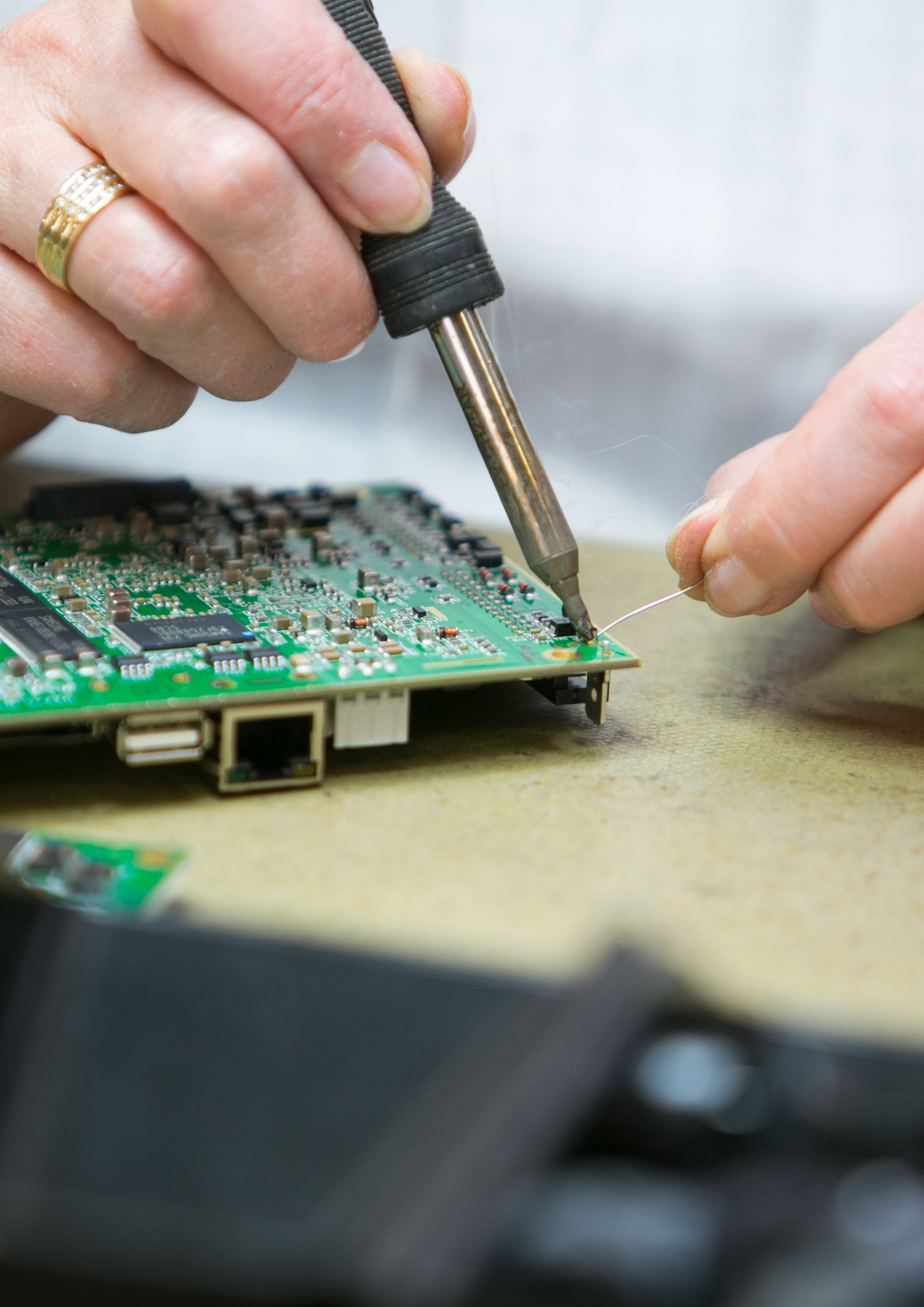



INTELLIGENT / INTERACTIVE PANELS AND DETECTORS / DEVICES	16-31
PANELS	18
Intelligent Fire Detectors.....	24
Addressable Manual Call Points.....	26
Loop Sounders.....	26
Interface Loop Units.....	27
Programming and Maintenance Tool.....	27
ADDRESSABLE GENERAL VIEW.....	28-29



INTELLIGENT/INTERACTIVE PANELS AND DETECTORS/DEVICES

PANELS

From 1 to 128 addresses

HEPHAIS 128

INTELLIGENT/INTERACTIVE COMPACT CONTROL PANEL, 128 ADDRESSES, 2 loops or 4 open circuits (open circuit with max 32 addresses), 99 ZONES, 1000 memory events, 1 monitored sounders line + 5 programmable output relays, 1xRS232 serial output for printer or remote control panel, 2 programmable inputs. The panel can be set by keyboard or software. Needs 2 internal batteries 12V/7Ah. EN54-2, EN54-4, EN54-13 CE according to CPD/CPR



TELEHEPHAIS 128

SOFTWARE PROGRAMMING TOOL for HEPHAIS 128, uploading/downloading



AJ127

Serial cable for software PROGRAMMING TOOL



From 1 to 400 addresses

HEPHAIS 1600 NE COMFORT

INTELLIGENT/INTERACTIVE COMPACT CONTROL PANEL, NOT EXPANDABLE, 400 ADDRESSES, 2 master loops or 4 spur circuits (open circuit with max 32 addresses), USER INTERFACE FRONT PANEL (command and control) TFT COLOR GRAPHIC DISPLAY 4.3inches ,1000 ZONES, 2700 memory events, 2 monitored sounders lines + 3 programmable output relays, 1xRS232 serial output for remote control panel, 2 programmable inputs, RS422 JBUS monitoring output. TCP/IP Connection for safe remote monitoring interface. Needs 2 internal batteries 12V/12Ah. EN54-2, EN54-4, EN54-13 CE according to CPD/CPR



TELEHEPHAIS 1600

SOFTWARE PROGRAMMING TOOL for HEPHAIS 1600 NE and HEPHAIS 1600

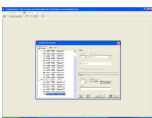

AJ127

Serial cable for software PROGRAMMING TOOL



Specific software

LOCK 1600-3

CUSTOMER SIGNATURE PROTECTION Hardware Key for HEPHAIS 1600 NE and HEPHAIS 1600. Permits with TELEHEPHAIS 1600 to upload/download the panel with your own signed protection key, PACK of 3xKEYS, with or without time bomb



TIME BOMB RENEW

Renewal of 1 year time bomb



Options

Relay card

R7P2

7 RELAY CARD, NO-NC 30V/1A, to be plugged inside the panel, serial communication, permits to repeat states of the panel on 7 relays



R12P2

12 RELAY CARD, NO-NC 30V/1A, to be plugged inside the panel, serial communication, permits to repeat states of the panel on 12 relays



Remote monitoring panel

ALPHA RE

REMOTE USER INTERFACE PANEL with serial 485 connection, alphanumeric display LCD 160 characters and keyboard



Options

Relay card

R7P2

7 RELAY CARD, NO-NC 30V/1A, to be plugged inside the panel, serial communication, permits to repeat states of the panel on 7 relays



R12P2

12 RELAY CARD, NO-NC 30V/1A, to be plugged inside the panel, serial communication, permits to repeat states of the panel on 12 relays



C20R

20 RELAY CARD, NO-NC 30V/1A, to be plugged inside the panel, serial communication, permits to repeat states of the panel on 20 relays

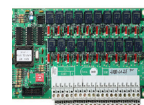

Sounder circuit

X4EVAC

4 MONITORED WAYS SOUNDER CIRCUIT extension board, permits to multiply 1 sounder circuit in 4 activated simultaneously, to be plugged inside the panel



Remote monitoring panel

TR15 TOUCH

Repeater for addressable systems with 7inches colour touchscreen and advanced user-friendly interface.



MIHMING-EXT

COMMUNICATION CARD FOR COMFORT USER INTERFACE FRONT PANEL. This card is necessary for a remote use of COMFORT 1600 front panel or TR15 Touch connection.





INTELLIGENT/INTERACTIVE PANELS AND DETECTORS/DEVICES

HEPHAIS 128 : FROM 1 TO 128 ADDRESSES

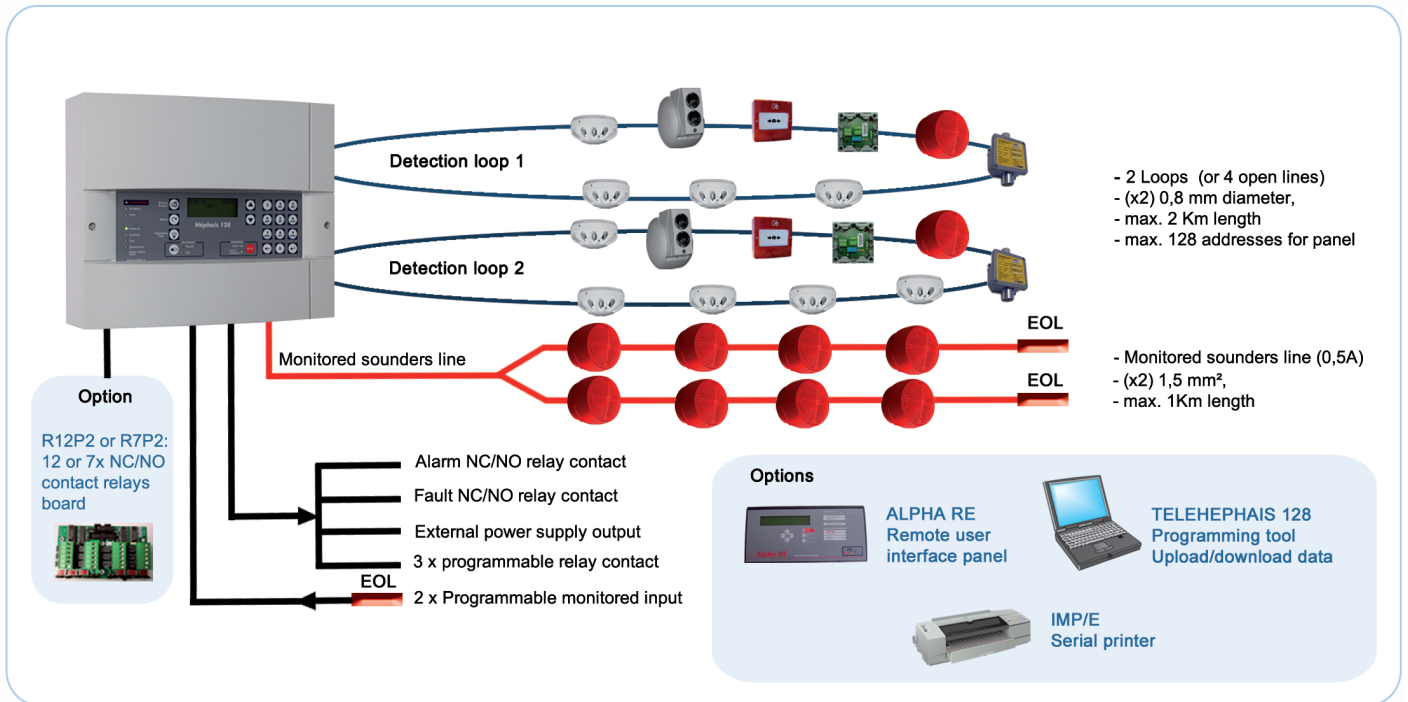

HEPHAIS 1600 NE COMFORT : FROM 1 TO 400 ADDRESSES

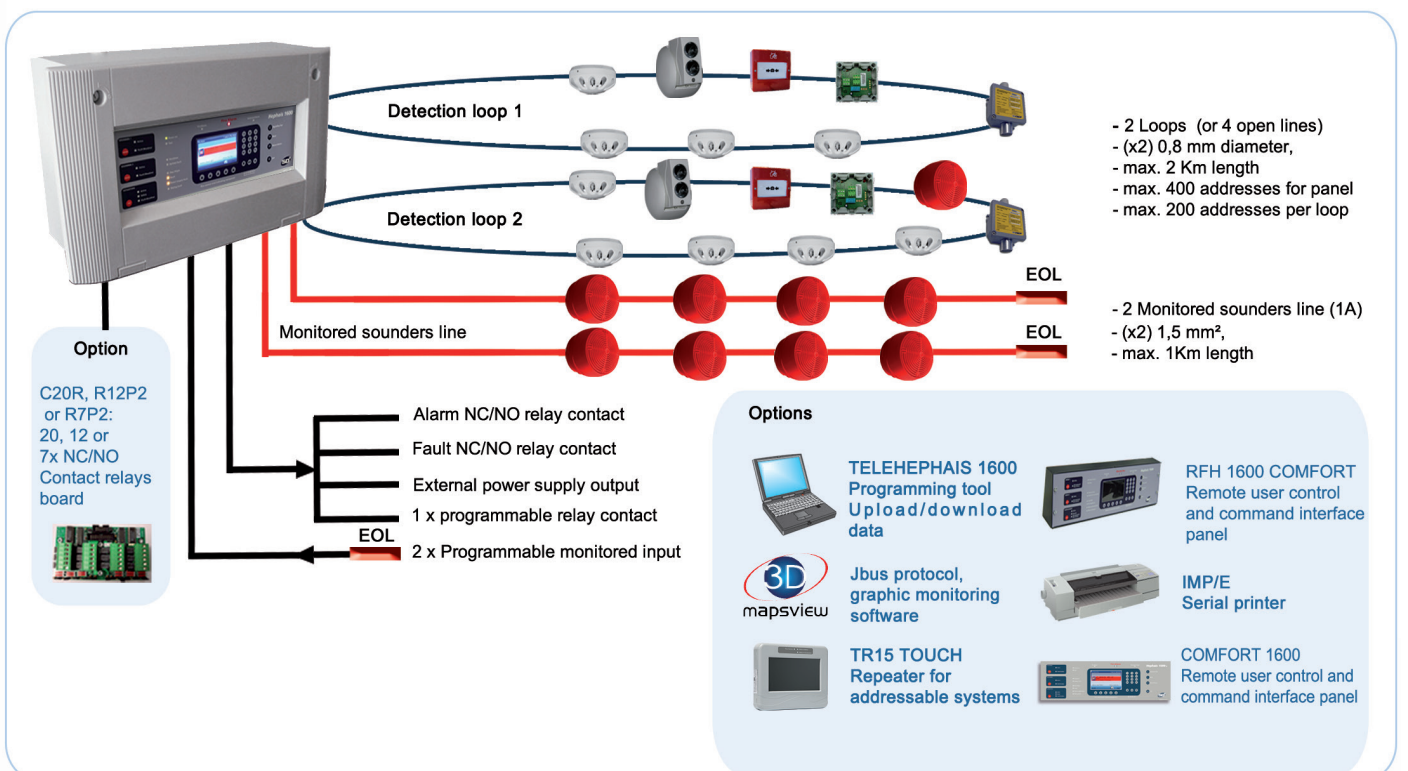



PANELS

From 1 to 1600 addresses



HEPHAIS 1600-400 COMFORT/L

MODULAR INTELLIGENT/INTERACTIVE FIRE CONTROL PANEL MAX 1600 POINTS, 16 LOOPS - supplied as standard for 400 points on 2 master loops (max 200 addresses/loop) or 4 open circuits, expandable up to 7 x MG2B (loop boards), in large box with integrated **USER INTERFACE FRONT PANEL (command and control) TFT COLOR GRAPHIC DISPLAY 4.3inches**, and keyboard, 1000 Zones, 2700 memory events, 2 monitored sounders lines + 3 programmable output relays, 1xRS232 serial output for printer and 1xRS485 serial output for remote control panel, 4 programmable inputs, RS422 JBUS monitoring output, networkable with MGNET board. **TCPIP Connection for safe remote monitoring interface**. Needs 2 internal batteries 12V/17Ah or 12V/24Ah. **EN54-2, EN54-4, EN54-13, CE according to CPD/CPR**



HEPHAIS 1600-400 COMFORT/S

MODULAR INTELLIGENT/INTERACTIVE FIRE CONTROL PANEL MAX 1600 POINTS, 10 LOOPS - supplied as standard for 400 points on 2 master loops (max 200 addresses/loop) or 4 open circuits, expandable up to 4 x MG2B (loop boards), in small box with integrated **USER INTERFACE FRONT PANEL (command and control) TFT COLOR GRAPHIC DISPLAY 4.3inches**, and keyboard, 1000 Zones, 2700 memory events, 2 monitored sounders lines + 3 programmable output relays, 1xRS232 serial output for printer and 1xRS485 serial output for remote control panel, 4 programmable inputs, RS422 JBUS monitoring output, networkable with MGNET board. **TCPIP Connection for safe remote monitoring interface**. Needs 2 internal batteries 12V/12Ah. **EN54-2, EN54-4, EN54-13, CE according to CPD/CPR**



HEPHAIS 1600-400/L BB

MODULAR INTELLIGENT/INTERACTIVE FIRE CONTROL PANEL MAX 1600 POINTS, 16 LOOPS - supplied as standard for 400 points on 2 master loops (max 200 addresses/loop) or 4 spur circuits, expandable up to 7 x MG2B (loop boards), **in large box without front panel**, 1000 Zones, 2700 memory events, 2 monitored sounders lines + 3 programmable output relays and 1xRS485 serial output for remote control panel, 4 programmable inputs, RS422 JBUS monitoring output, networkable with MGNET board. Needs 2 internal batteries 12V/17Ah or 12V/24Ah. **EN54-2, EN54-4, EN54-13, CE according to CPD/CPR**



HEPHAIS 1600-400/COMFORT LPM

MODULAR INTELLIGENT/INTERACTIVE FIRE CONTROL PANEL MAX 1600 POINTS, 16 LOOPS - supplied as standard for 400 points on 2 master loops (max 200 addresses/loop) or 4 spur circuits, expandable up to 7 x MG2B (loop boards), in large metallic with integrated **USER INTERFACE FRONT PANEL (command and control) TFT COLOR GRAPHIC DISPLAY 4.3inches**, and keyboard 1000 Zones, 2700 memory events, 2 monitored sounders lines + 3 programmable output relays, 1xRS232 serial output for printer and 1xRS485 serial output for remote control panel, 2 programmable inputs, RS422 JBUS monitoring output, networkable with MGNET board. **TCPIP Connection for safe remote monitoring interface**. Needs 2 internal batteries 12V/17Ah or 12V/24Ah. **EN54-2, EN54-4, EN54-13, CE according to CPD/CPR**



TELEHEPHAIS 1600

SOFTWARE PROGRAMMING TOOL for HEPHAIS 1600 range



AJ127

Serial cable for software PROGRAMMING TOOL

specific software



LOCK 1600-3

CUSTOMER SIGNATURE PROTECTION Hardware Key for HEPHAIS 1600 NE and HEPHAIS 1600. Permits with TELEHEPHAIS 1600 to upload/download the panel **with your own signed protection key, PACK of 3xKEYS, with or without time bomb**

TIME BOMB RENEW

RENEWAL of 1 year time bomb



INTELLIGENT/INTERACTIVE PANELS AND DETECTORS/DEVICES

PANELS

HEPHAIS 1600 range

Loop card

MG2B

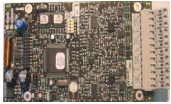

EXTENSION MODULE 2 LOOPS (max 200 points per loop) or 4 spur circuits (max 32 points per circuit) to be plugged inside the panel

IE2M

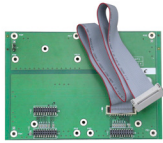

IE2M is an extension board with connectors allowing to connect from 2 to 4 MG2B. This board permits to expand the panel from 10 to 16 loops. Necessary if more than 10 loops needed

Network cards

MGNET



NETWORK CARD, must be plugged in each panel for network application, network done with RS485 redundant connection

Relay card

R7P2



7 RELAY CARD, NO-NC 30V/1A, to be plugged inside the panel, serial communication, permits to repeat states of the panel on 7 relays

R12P2



12 RELAY CARD, NO-NC 30V/1A, to be plugged inside the panel, serial communication, permits to repeat states of the panel on 12 relays

C20R



20 RELAY CARD, NO-NC 30V/1A, to be plugged inside the panel, serial communication, permits to repeat states of the panel on 20 relays

Sounder circuit

X4EVAC



4 MONITORED WAYS SOUNDER CIRCUIT extension board, permits to multiply 1 sounder circuit in 4 activated simultaneously, to be plugged inside the panel

Options

Printers



IMP

INTERNAL SERIAL FLUSH MOUNTED PRINTER can be directly mounted in metallic box of HEPHAIS 1600 or through CACHE-IMPRI-3U piece for plastic box



CACHE-IMPRI-3U

MOUNTING KIT front panel to flushmount IMP printer in HEPHAIS 1600 COMFORT 1600-400/L



IMP/E

EXTERNAL SERIAL PRINTER, dimensions 165x135x50mm

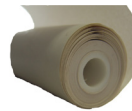

KCT10

PACK OF 10 THERMIC PAPER ROLLS

Remote monitoring and command panel

RFH 1600 COMFORT



USER INTERFACE FRONT PANEL (command and control) TFT COLOR GRAPHIC DISPLAY 4.3inches, and keyboard, 19 inches, 3U, can be integrated in cabinet or in CO3U console. TCP/IP Connection for safe remote monitoring interface



CO3U

PLASTIC BOX CONSOLE for RFH 1600 front panel or COMFORT 1600



TR15 TOUCH

Repeater for addressable systems with 7inches colour touchscreen and advanced user-friendly interface.



MIHMNG-EXT

COMMUNICATION CARD FOR COMFORT USER INTERFACE FRONT PANEL. This card is only necessary for a remote use of COMFORT 1600 front panel

Remote monitoring panel

ALPHA RE



REMOTE USER INTERFACE PANEL with serial 485 connection, alphanumeric display LCD 160 characters and keyboard



TR15 TOUCH

Repeater for addressable systems with 7inches colour touchscreen and advanced user-friendly interface.

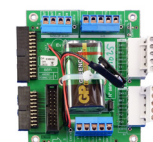

MIHMNG-EXT

COMMUNICATION CARD FOR COMFORT USER INTERFACE FRONT PANEL. This card is necessary for a remote use of COMFORT 1600 front panel or TR15 Touch connection.



INTELLIGENT/INTERACTIVE PANELS AND DETECTORS/DEVICES

HEPHAIS 1600 COMFORT : FROM 1 TO 1600 ADDRESSES

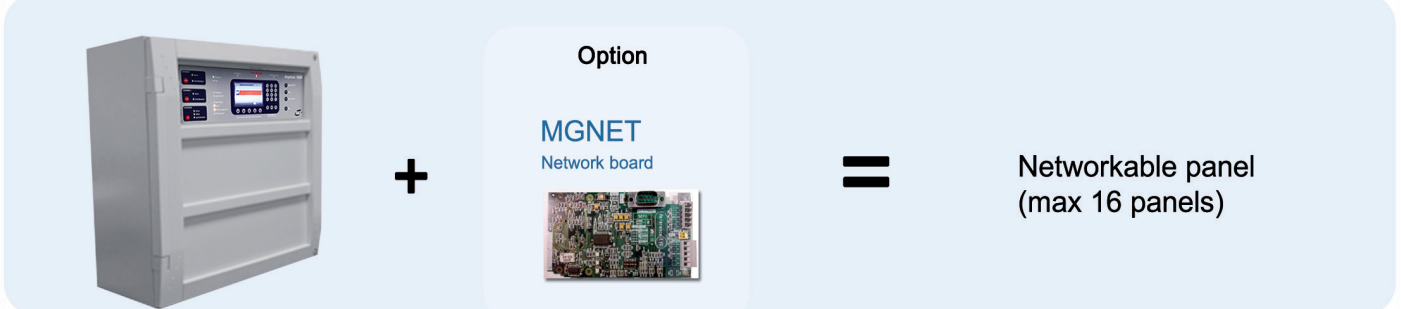
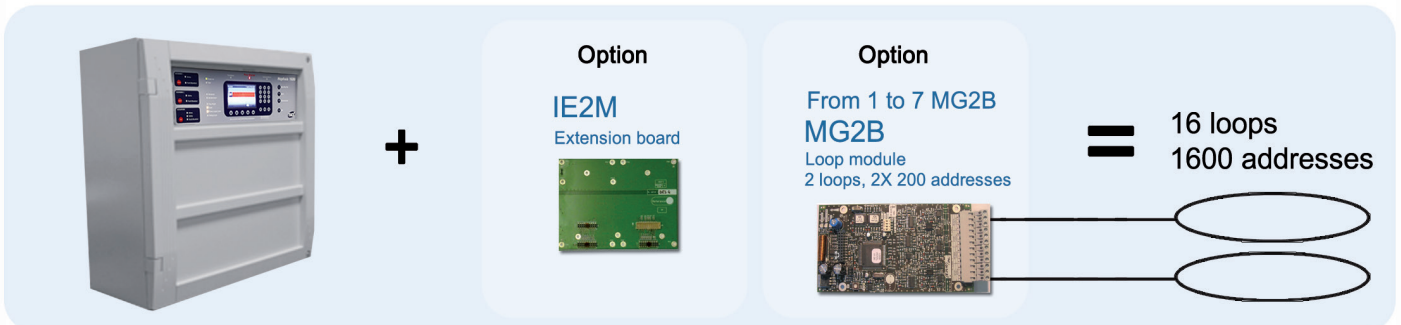
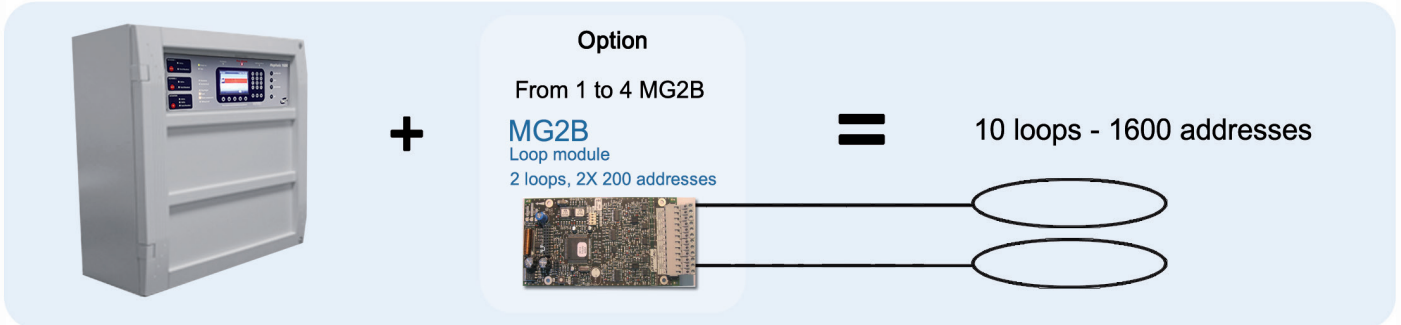
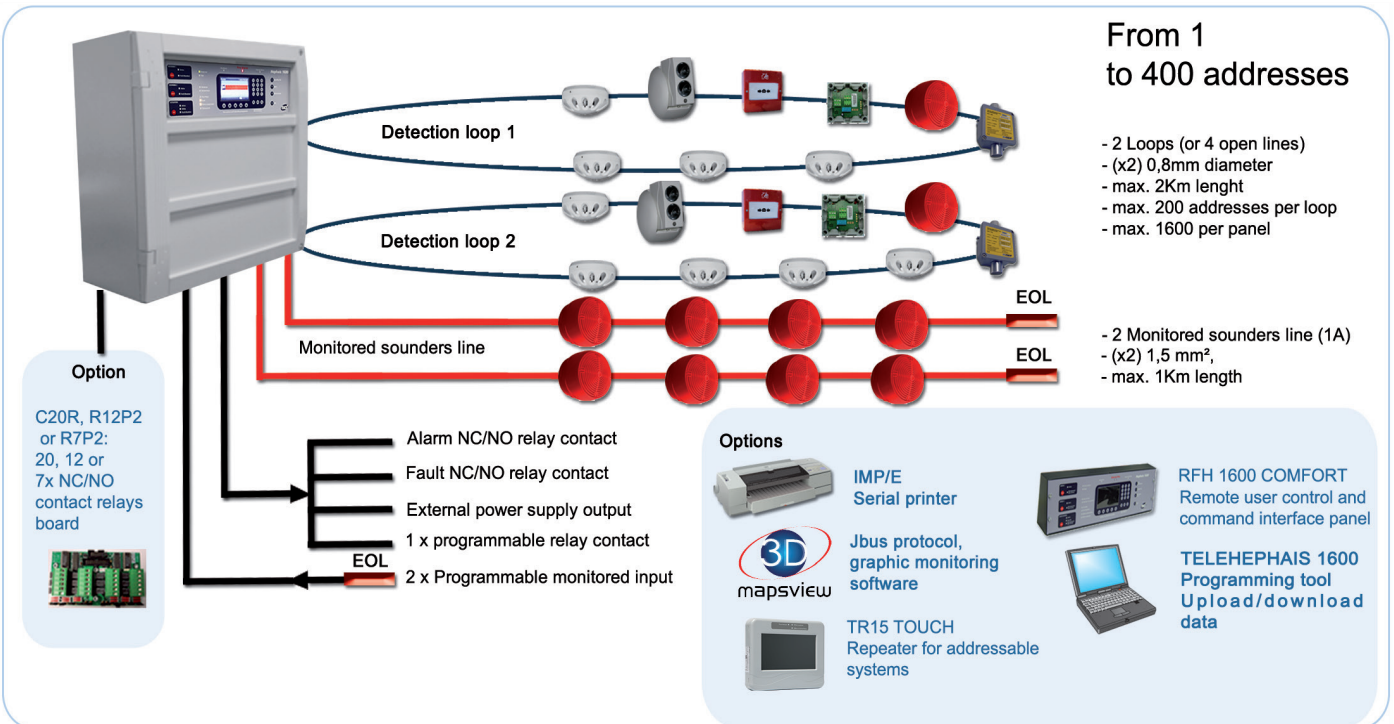



INTELLIGENT/INTERACTIVE PANELS AND DETECTORS/DEVICES

Network of HEPHAIS 1600 COMFORT PANEL

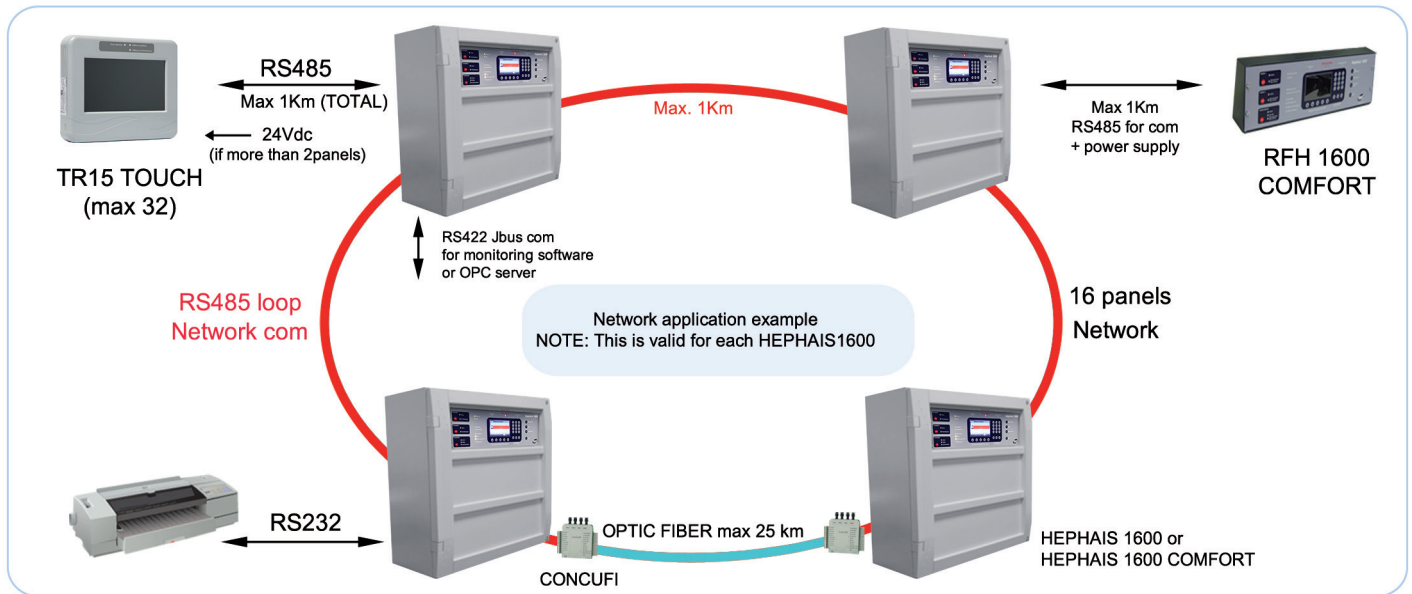

FIREWEB

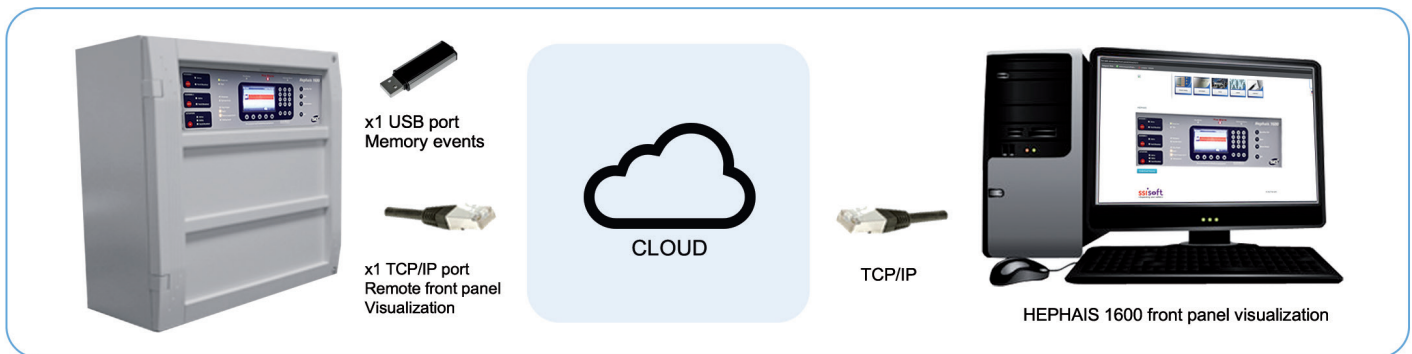

FIREWEB SERVER / TCPIP REMOTE CONNECTION on COMFORT 1600 and 1600NE panels

FWS-CX-12

12 months license for **remote monitoring AND commands** for HEPHAIS 1600 NE COMFORT or HEPHAIS 1600 COMFORT through TCPIP connection and cloud. With local authorization (X=A) or without (X=O). Validity time before renewal = 12 months

FWS-CX-36

36 months license for **remote monitoring AND commands** for HEPHAIS 1600 NE COMFORT or HEPHAIS 1600 COMFORT through TCPIP connection and cloud. With local authorization (X=A) or without (X=O). Validity time before renewal = 36 months

FWS-VX-12

12 months license for **remote monitoring** for HEPHAIS 1600 NE COMFORT or HEPHAIS 1600 COMFORT through TCPIP connection and cloud. With local authorization (X=A) or without (X=O). Validity time before renewal = 12 months

FWS-VX-36

36 months license for **remote monitoring** for HEPHAIS 1600 NE COMFORT or HEPHAIS 1600 COMFORT through TCPIP connection and cloud. With local authorization (X=A) or without (X=O). Validity time before renewal = 36 months





INTELLIGENT FIRE DETECTORS

05 range

OA05

INTELLIGENT/INTERACTIVE OPTICAL SMOKE DETECTOR, microprocessor based, 1 programmable remote alarm indicator output, 8 levels sensitivity setting, EN54-7, CE according to CPD/CPR



TA05

INTELLIGENT/INTERACTIVE HEAT DETECTOR, static or/and rate of rise, microprocessor based , 1 programmable remote alarm indicator output, 6 levels sensitivity setting, EN54-5, CE according to CPD/CPR



MA05

INTELLIGENT/INTERACTIVE OPTICAL-HEAT DETECTOR, multicriteria or combined, microprocessor based, 1 programmable remote alarm indicator output, 8 levels sensitivity setting, EN54-7, CE according to CPD/CPR



Detector range with integrated isolator

OA12

INTELLIGENT/INTERACTIVE OPTICAL SMOKE DETECTOR, WITH EMBEDDED ISOLATOR, microprocessor based, 1 programmable remote alarm indicator output, 8 levels sensitivity setting, EN54-7, CE according to CPD/CPR



TA12

INTELLIGENT/INTERACTIVE HEAT DETECTOR, WITH EMBEDDED ISOLATOR, static or/and rate of rise, microprocessor based, 1 programmable remote alarm indicator output, 6 levels sensitivity setting, EN54-5, CE according to CPD/CPR



MA12

INTELLIGENT/INTERACTIVE OPTICAL-HEAT DETECTOR, WITH EMBEDDED ISOLATOR, multicriteria or combined, microprocessor based, 1 programmable remote alarm indicator output, 8 levels sensitivity setting, EN54-7, CE according to CPD/CPR



Bases and accessories

Standard base

S05SE

UNIVERSAL BASE WITH STICK ADDRESS SOCKET for 05-range conventional and addressable detectors



Accessories for S05 base

PES05

FLUSHMOUNTING PIECE FOR BASE (Base not included), permits to flushmount a 05 range detector



BRI/EM + S05SE

Universal base with GLANDS HOLE for 05 range, base with tubes connections



BRI+ S05SE

WATERPROOF universal base with glands for 05 range (IP65), base with tubes connections supplied with glands





INTELLIGENT/INTERACTIVE PANELS AND DETECTORS/DEVICES

Sounder base with S05 base



SOUND05 + S05SE

BASE WITH INTERNAL SOUNDER 95db @ 1m, Possibility to select 6 tones and 3 intensity levels, EN54-3, CE according to CPD/CPR

Isolator for 05 range

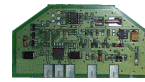

ICC05

PLUG IN ISOLATOR BOARD for 05 detectors (to be plugged in S05SE)

Bases and accessories for 05 & 12

S12 double terminal, no screw drivers bases



S12

UNIVERSAL BASE WITH STICK ADDRESS SOCKET for 05 and 12 range conventional and addressable detectors. Double terminal block, no screw driver, easy wiring. Sold by pack of 10. Label plate support included.

Accessories for base



PSS15

Mounting adapter to secure fixing S12 on suspended false ceiling. Sold by pack of 900



KMIPN

Fastening kit to fix the detector base S12 on steel beam. Exists for thickness 3-8mm, 8-14mm, 14-20mm



PMSP

Fastening kit to the detector base S12 under raised floor



OAR15

Optional tool for wiring and stripping



PES12

FLUSHMOUNTING PIECE FOR BASE permits to flushmount a 05, 12 range base including wiring connection and label holder



BRI/EM + S12

Universal base with GLANDS HOLE for 05 and 12 range, base for tubes connections



BRI + S12

WATERPROOF universal base with glands for 05 and 12 range (IP65), base for tubes connections supplies with glands

Sounder base with S12 base



SOUND05 + S12

BASE WITH INTERNAL SOUNDER 95db @ 1m. Possibility to select 6 tones and 3 intensity levels, EN54-3, CE according to CPD/CPR

Accessories for S05 and S12 Bases



GAV

ANTIVANDALISM protection grid

Addressable flame detector



IR95+S95

ANALOGUE/ADDRESSABLE INFRARED FLAME DETECTOR, microprocessor based, 1 programmable remote alarm indicator output, base included EN54-10 CE according to CPD/CPR



ADDRESSABLE MANUAL CALL POINTS

05 range

DMA05

ADDRESSABLE MANUAL CALL POINT
resettable with key without breaking glass,
integrated isolator, red colour,
EN54-11, EN54-17, CE according to CPD/CPR



DMA05R

ADDRESSABLE MANUAL CALL POINT
resettable with key without breaking glass,
integrated isolator and programmable relay
output, red colour, EN54-11, EN54-17,
EN54-18 CE according to CPD/CPR

Accessories

PEDM

PLASTIC FRAME for flush mounting MCP



VPDM

TRANSPARENT LIFT-UP protective cover for MCP,
permits a double action (supplied with
protection label)



05 waterproof MCP

DMA05 E

ADDRESSABLE WATERPROOF MANUAL CALL
POINT - resettable with key
without breaking glass, integrated
isolator, red colour, EN54-11, EN54-17, CE
according to CPD/CPR



KCTDM

KIT OF 10 RESET KEYS for 05 MCP



LOOP SOUNDERS

AVSA05/R (AVSA 2000)

ADDRESSABLE HIGH POWERED PIEZOELECTRIC SOUNDER for indoor use (red colour), integrated isolator,
possibility to select 6 tones, 95db@1m, lateral hearings, loop powered, for HEPHAIS 1600 range .
Certified EN54-3 according to CPD





INTERFACE LOOP UNITS



MAY1

ADDRESSABLE ZONE INTERFACE MODULE with backbox, for max 32 conventional points



MBA95

ADDRESSABLE ZONE INTERFACE MODULE with backbox, for max 32 conventional points, isolator integrated, opto-isolated on the secondary line, EN54-17, EN54-18, EN54-13 CE according to CPD/CPR



ETC05-B

ADDRESSABLE INPUT/OUTPUT MODULE with backbox, isolator integrated, NO or NC monitoring for input, relay output NO-NC 30V/1A, EN54-17, EN54-18 CE according to CPD/CPR (exists also in RAIL DIN version)



ET4C05-B

ADDRESSABLE 4 INPUT/OUTPUT MODULE with backbox, isolator integrated, NO or NC monitoring for input, relay output NO-NC 30V/1A, EN54-17, EN54-18 CE according to CPD/CPR

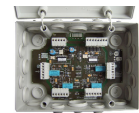

EDL

ADDRESSABLE 2 MONITORED INPUT + 1 MONITORED LINE OUTPUT permits to manage NO or NC for the monitored inputs and use monitored sounders line for outputs, EN54-17, EN54-18, CE according to CPD/CPR

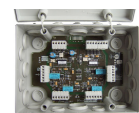

ED4L

ADDRESSABLE 8 MONITORED INPUT + 4 MONITORED LINE OUTPUT permits to manage NO or NC for monitored inputs and use monitored sounders line for outputs, EN54-17, EN54-18, CE according to CPD/CPR



MIMIC B60

DIN RAIL MOUNTING 60 ADDRESSABLE outputs dedicated for Mimic panel leds

PROGRAMMING, TEST AND MAINTENANCE TOOL



ECDL 500

Portable tool for commissioning, troubleshooting, and maintenance operations of the addressable loop. It also enables the wiring verification of the conventional lines, delivered in a suitcase with an adapter/charger, a USB cable and a specific cable equipped with crocodiles' clips. It is compatible with the A95, A05, and A12 ranges of addressable devices. Mostly, it is a useful and essential tool to validate your installation before start-up

HEPHAIS RANGE



HEPHAIS 128



HEPHAIS 1600 NE COMFORT



HEPHAIS 1600-400 COMFORT/L

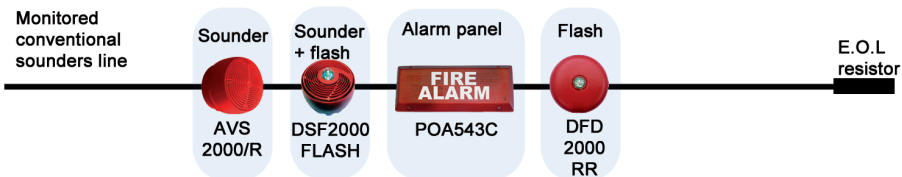
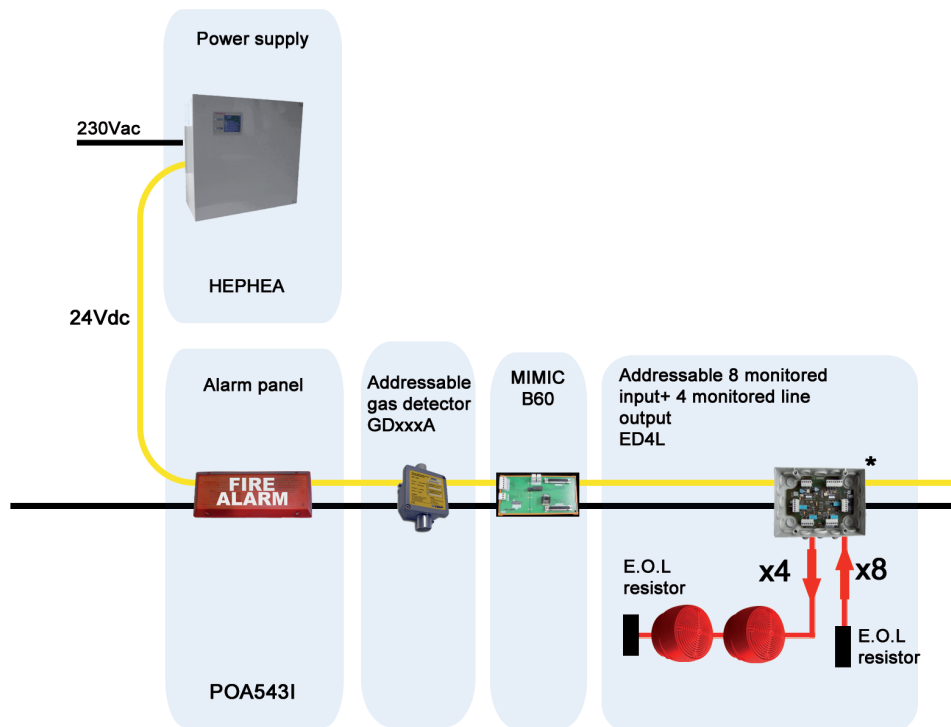
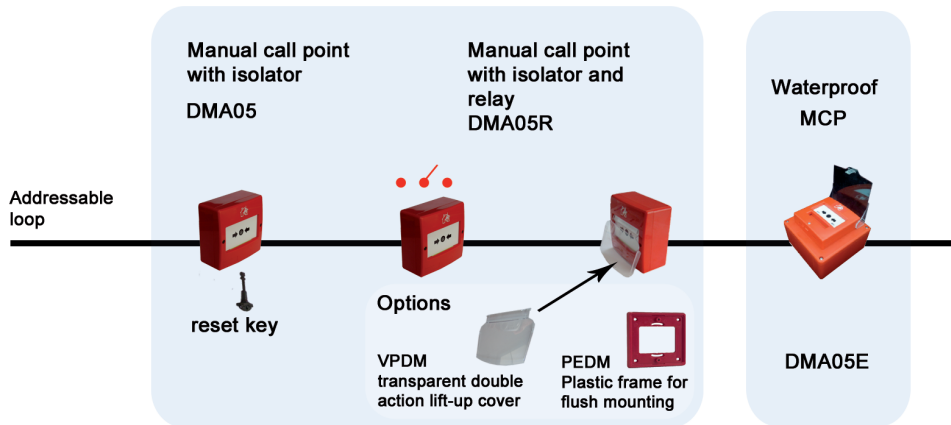

*Only for HEPHAIS 1600 NE and HEPHAIS 1600



ADDRESSABLE GENERAL VIEW

Smoke, heat, multicriteria, combined detector
OA05, TA05, MA05, OA12, TA12, MA12



IND05 alarm indicator

Flushmounting piece for detector
PES05



S05SE Base
Smoke, heat, multicriteria, combined detector
OA05, TA05, MA05, OA12, TA12, MA12

FLUSHMOUNTED DETECTOR



Smoke, heat, multicriteria, combined detector
OA05, TA05, MA05, OA12, TA12, MA12

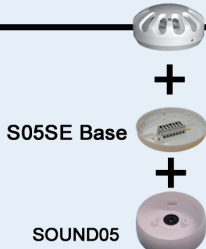

S05SE Base

SOUND05

DETECTOR WITH SOUNDER BASE
95 dB @ 1m



Smoke, heat, multicriteria, combined detector
OA05, TA05, MA05, OA12, TA12, MA12

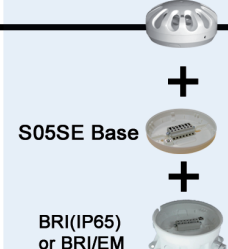

S05SE Base

BRI(IP65) or BRI/EM

DETECTOR WITH TUBE CONNECTIONS



Addressable zone interface module
MAY1, MBA95



conventional detector



E.O.L resistor

input/output modules
ETC05, ET4C05,



E.O.L resistor

Wireless solutions
OI05, OA05-W, DMA05-W, IND05-W



Addressable sounder
95db@1m



AVSA 05

Beam detector
DLFBI
DLFB30I



Infrared flame detector
IR95 + S95 base
Infrared flame detector
typical distance = 17m

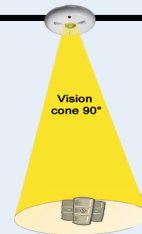

Air duct detector housing



BTG05
with detector :
OA05, OA12

ECDL 500
PORTABLE TOOL FOR ADDRESSABLE
DETECTORS AND DEVICES







SPECIAL PRODUCTS	30-5
LINEAR SMOKE DETECTORS	32
WIRELESS SOLUTIONS.....	33
AIR SAMPLING DETECTION	34-35
GAS DETECTION	36-37
EXPLOSION PROOF GAS DETECTION	38
DEVICES FOR FIRE EVACUATION.....	39
MONITORING SOFTWARE.....	40-41
EXPLOSION HAZARD AREA FIRE DETECTION.....	42-43
EXTINGUISHING SYSTEMS.....	44
MARINE	45-46
ACCESSORIES FOR FIRE ALARM SYSTEM	46
HEPHEA RANGE POWER SUPPLY.....	46
VOICE EVACUATION SYSTEMS	47-48
ELECTRIC LOCK FOR EMERGENCY EXIT DOORS	48
FIRE ALARM CABLE.....	49
MAINTENANCE AND TEST EQUIPMENT.....	49-50



LINEAR SMOKE DETECTORS

From 3 to 30m

DLFB30 I

INTELLIGENT INTERACTIVE BEAM DETECTOR (loop powered) for linear smoke detection supplied with reflector for distance from 3 up to 30 meters, integrated isolator, integrated laser pointer for alignment, EN54-12, EN54-17, CE according to CPD/ CPR



DLFB30 R

RELAY BEAM DETECTOR, for linear smoke detection supplied with reflector for distance from 3 up to 30 meters, NO-NC ALARM, NO-NC FAULT, integrated laser pointer for alignment, EN54-12, CE according to CPD/ CPR

From 3 to 100m

DLFBe I

INTELLIGENT INTERACTIVE BEAM DETECTOR (loop powered) for linear smoke detection supplied with reflector for distance from 3 up to 100 meters, integrated isolator, visible ray for alignment, EN54-12, EN54-17, CE according to CPD. Exists also in conventional version with ALPHA panel, DLFBe C



DLFBe R

RELAY BEAM DETECTOR, for linear smoke detection supplied with reflector for distance from 3 up to 100 meters, NO-NC ALARM, NO-NC FAULT, visible ray for alignment, EN54-12, CE according to CPD

Accessories

DETTTEL

REMOTE CONTROL WITH DISPLAY AND KEYPAD for DLFB30 and DLFBe, permits to adjust the alignment and program the beam



BEAM-BR

REMOTE BOX FOR BEAM, permits remotely to enable/disable, reset, can be connected with remote control DETTEL, 4 to 5 wires connections to the beam



BEAM-KIT4CC

SUNSHIELD PROTECT FOR REFLECTOR, supplied for 4 reflectors 10x10 reflectors, permits to protect against sun rays



BEAM-FMBOX

FLUSHMOUNTING box for DLFB30

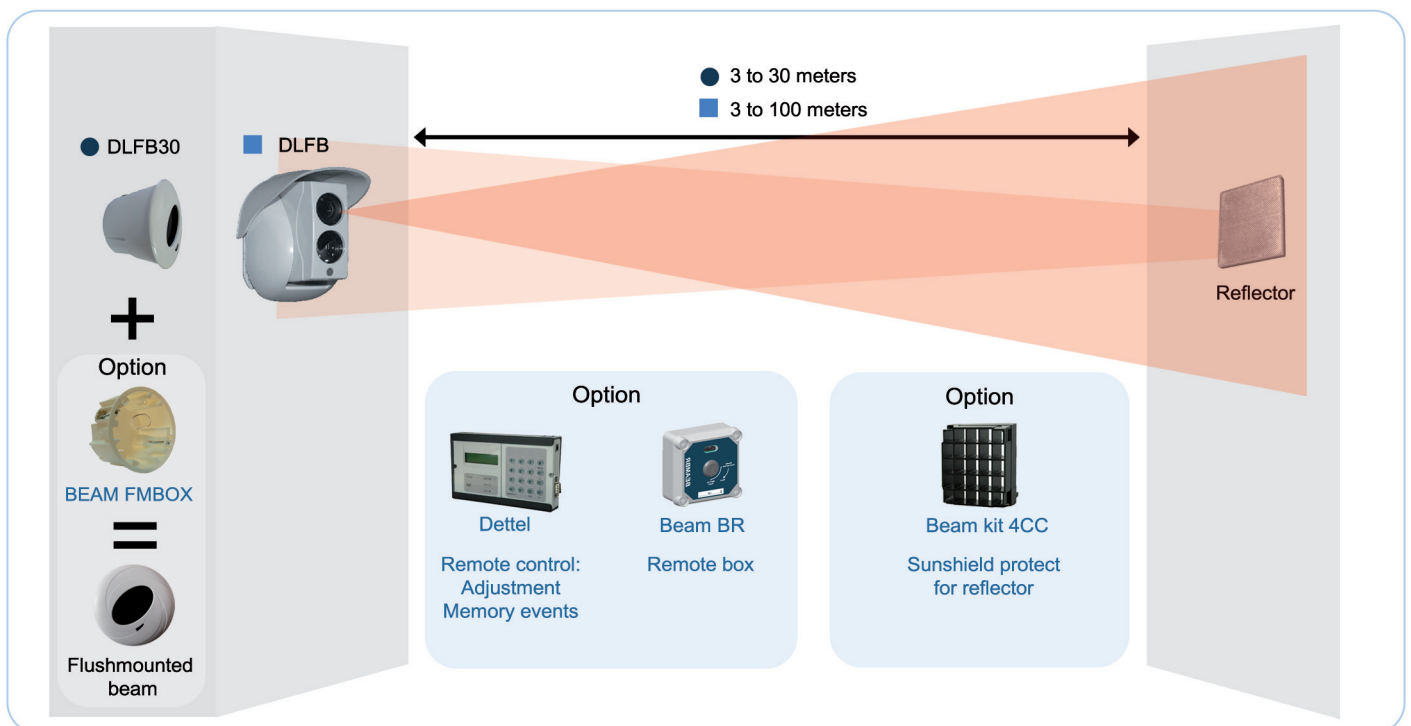



WIRELESS SOLUTIONS



OA05-W

WIRELESS OPTICAL SMOKE DETECTOR, 1 remote led output, EN54-7, EN54-25, CE according to CPD/CPR



DMA05-W

WIRELESS MANUAL CALL POINT, 1 remote led output, EN54-11, EN54-25, CE according to CPD/CPR



IND05-W

WIRELESS REMOTE INDICATOR, angle of vision = 180°, EN54-18, EN54-25, CE according to CPD/CPR



OI05

MONITORING MODULE can be connected on HEPHAIS 1600 or HEPHAIS 1600NE, 1 remote led output, monitoring device of wireless equipments EN54-17, EN54-18, EN54-25, CE according to CPD/CPR



TELEWIRELESS

SOFTWARE PROGRAMMING TOOL for WIRELESS SOLUTIONS

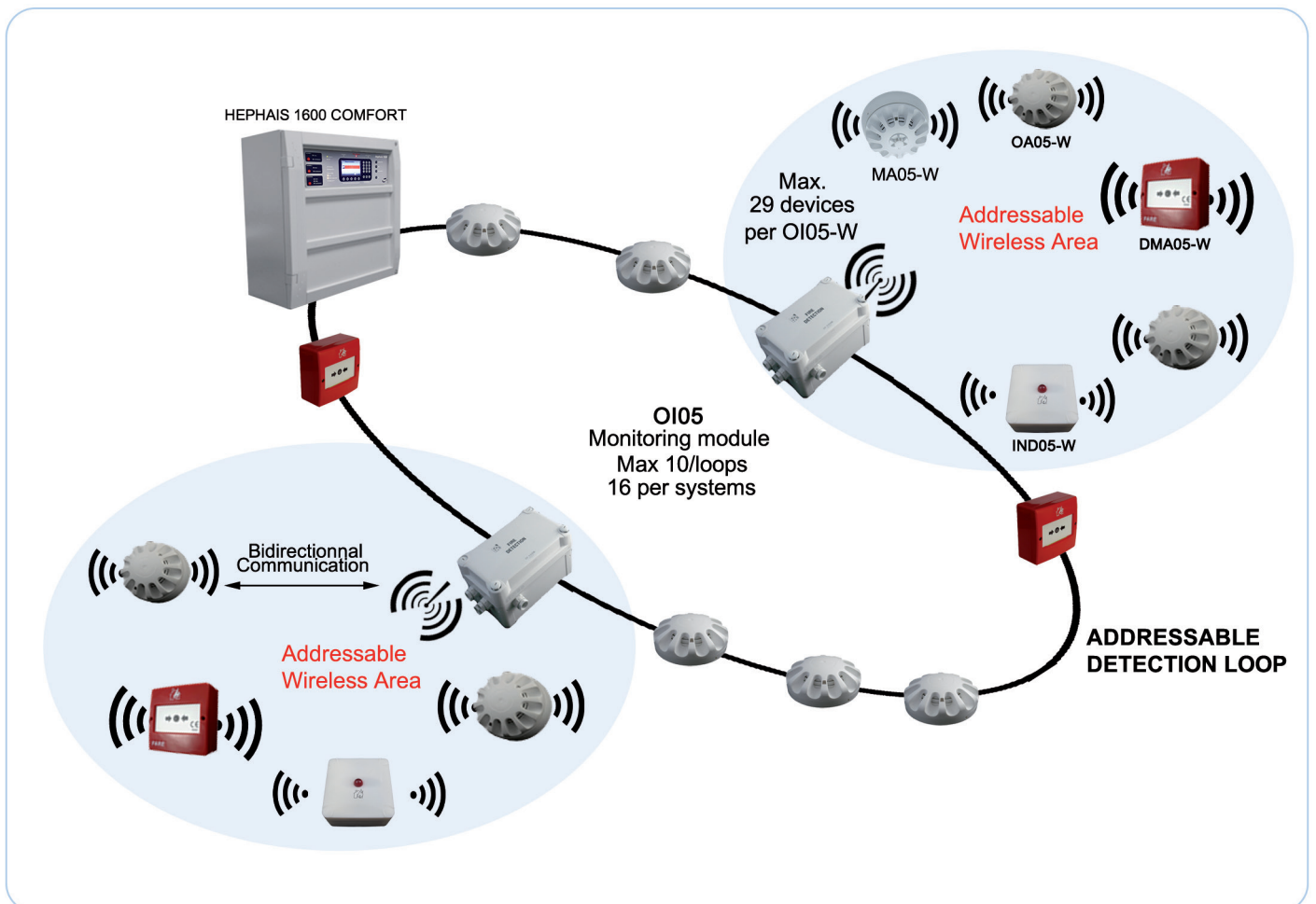



AIR SAMPLING DETECTION

WITH HIGH SENSITIVITY DETECTORS

DFA05-1C-B (DFA05-3)

CONVENTIONAL SINGLE CHANNEL HIGH SENSITIVITY BASE DETECTOR for one sampling tube with smoke level indicator, to be completed with one detector module SSD, EN54-20 CE according to CPD/CPR

DFA05-2C-B (DFA05-4)

CONVENTIONAL DUAL CHANNEL HIGH SENSITIVITY BASE DETECTOR , for one or two sampling tubes with smoke level indicator, to be completed with one or two detectors modules SSD, EN54-20 CE according to CPD/CPR



DFA05-1C (DFA05-1)

CONVENTIONAL SINGLE CHANNEL HIGH SENSITIVITY BASE DETECTOR, for one sampling tube, to be completed with one detector module SSD, EN54-20 CE according to CPD/CPR

DFA05-2C (DFA05-2)

CONVENTIONAL DUAL CHANNEL HIGH SENSITIVITY BASE DETECTOR, for one or two sampling tubes, to be completed with one or two detectors modules SSD, EN54-20, CE according to CPD/CPR

Detector modules

SSD 535-1

HIGH SENSITIVITY SMOKE DETECTOR MODULE with alarm sensitivity range from 0,05%/m to 10%/m to be plugged in DFA05



SSD 535-2

HIGH SENSITIVITY SMOKE DETECTOR MODULE with alarm sensitivity range from 0,01%/m to 10%/m to be plugged in DFA05

SSD 535-3

HIGH SENSITIVITY SMOKE DETECTOR MODULE with alarm sensitivity range from 0,002%/m to 10%/m to be plugged in DFA05

Interface modules

RIM35

RELAY INTERFACE MODULE with 5 programmable relays, NO-NC 30V/1A to be plugged in DFA05

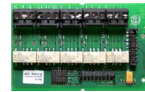

MCM35

SD-1GO MEMORY CARD MODULE to be plugged in DFA05 permits to record operating data and store memory events



SMM535

Box for network. Interface between network and computer



SIM 35

Plug in board for network . Permits to have RS485 with addressable network between DFA05, up to 250 devices

PROGRAMMING SOFTWARE FOR DFA05

SAMPLING PIPE CONFIG

SYSTEM DESIGN SOFTWARE permits to define the network pipe



DFA05 CONFIG

PROGRAMMING SOFTWARE permits to download/upload data configuration through USB cable (not supplied)

MINI AIR SAMPLING DETECTION for 12 holes max

DFA05 Mini-40

CONVENTIONAL SINGLE CHANNEL ASPIRATION DETECTOR

For one sampling tube network with a maximum of 12 sampling holes which includes its own smoke module 0.02%/m to 10%/m. Max length of the last hole = 40m. Total length max of network tubes = 75m. EN54-20, CE marking according to CPD/CPR



Interface module

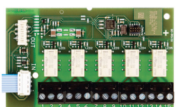

RIM36

RELAY INTERFACE MODULE

With 5 programmable relays, NO-NC 30V/1A to be plugged in DFA05 Mini-40



AIR SAMPLING DETECTION

FILTERS



FBS 25PC

Filter Box Small Ø 25 mm, PC

Filter mat-S

Filter Mat Small for FBS 25 PC



DFU 911

Filter Box Large Ø 25 mm, PC



RFC 911

Spare Filter



DTP 25 PC

Dust box, PC, adapted to all material Ø 22 - 25 mm pipe



DRB 25 PVC

Dust retaining box (cyclone), Ø 25 mm PVC



WRB 25 PVC

Water retaining box, Ø 25 mm, PC/PVC. Linking by gland on sampling pipe side and by glue on aspirating smoke side



WRB 25 ABS

Water retaining box Ø 25 mm, PC/ABS. Linking by gland on sampling pipe side and by glue on aspirating smoke side

MV 25 ABS

Manual ball valve Ø 25 mm, ABS, for maintenance use

ASPIRATING PIPES



TU25RF

FIREPROOF AIR SAMPLING PIPE 25mm (3m length), red colour (batch of 30)



EN25RF

FIREPROOF STRAIGHT SOCKET 25mm, red colour, (batch of 20)



TE25RF

FIREPROOF EQUAL TEE PIECE for 25mm tube, red colour, (batch of 10)



T 25/8

FIREPROOF EQUAL TEE PIECE for 8mm capillary tube or sample point, red colour, (batch of 10)



TT25RF

FIREPROOF END CAP, for 25mm tube, red colour, (batch of 10)



C90RF

FIREPROOF 90° ELBOW, for 25mm tube, red colour, (batch of 5)



CF70

FLEXIBLE ELBOW for 25mm tube, (batch of 4)



C45RF

FIRE PROOF 45° ELBOW, for 25mm tube, red colour, (batch of 5)



TF.10

Flexible tube 1m length



TC.8

CAPILLARY TUBE (10mm OD; 8mm ID) (100m roll)



ABR

FIREPROOF PIPE CLIP for 25mm tube, red colour, (batch of 50)



UTRF

FIREPROOF UNION TUBE for 25mm tube, red colour, (batch of 10)



PMTU

SAMPLE POINT 8mm, (batch of 10)



PMC

CONIC SAMPLE POINT, (batch of 10)



PMPT

PLATE SAMPLE POINT with nut, (batch of 10)



PMP

PLATE SAMPLE POINT with screws, (batch of 10)



PMC/8

SAMPLE POINT for capillary tube, (batch of 10)



PCM/10

RAISE FOR CLIP, raises for 17mm, (batch of 10)



PRPM

EXTENSION LEAD for sample point, (batch of 10)



TL

WATERPROOF ENDCAP, (batch of 10)



CONVENTIONAL GAS DETECTORS

GD100C

CONVENTIONAL METHANE CATALYTIC GAS DETECTOR, CH₄, IP55, can be directly connected on ALPHA panel, alarm and prealarm resistors integrated, needs external power supply, **with possibility to use 4/20mA output**

GD101C

CONVENTIONAL BUTANE CATALYTIC GAS DETECTOR, IP55, can be directly connected on ALPHA panel, alarm and prealarm resistors integrated, needs external power supply, **with possibility to use 4/20mA output**

GD102C

CONVENTIONAL PETROL STEAM CATALYTIC GAS DETECTOR, IP55, can be directly connected on ALPHA panel, alarm and prealarm resistors integrated, needs external power supply, **with possibility to use 4/20mA output**

GD104C

CONVENTIONAL HYDROGENE CATALYTIC GAS DETECTOR, H₂, IP55, can be directly connected on ALPHA panel, alarm and prealarm resistors integrated, needs external power supply, **with possibility to use 4/20mA output**



GD105C

CONVENTIONAL CATALYTIC LIQUID PETROLEUM GAS DETECTOR, LPG, IP55, can be directly connected on ALPHA panel, alarm and prealarm resistors integrated, needs external power supply, **with possibility to use 4/20mA output**

GD106C

CONVENTIONAL PROPANE CATALYTIC GAS DETECTOR, C₃H₈, IP55, can be directly connected on ALPHA panel, alarm and prealarm resistors integrated, needs external power supply, **with possibility to use 4/20mA output**

GD113C

CONVENTIONAL CARBON MONOXIDE GAS DETECTOR, CO, IP55, ELECTROCHEMICAL CELL, can be directly connected on ALPHA panel, alarm and prealarm resistors integrated, needs external power supply, **with possibility to use 4/20mA output**

ADDRESSABLE GAS DETECTORS

GD100A

ADDRESSABLE METHANE CATALYTIC GAS DETECTOR, CH₄, IP55, can be directly connected on HEPHAIS loops, integrated isolator, needs external power supply

GD101A

ADDRESSABLE BUTANE CATALYTIC GAS DETECTOR, CH₄, IP55, can be directly connected on HEPHAIS loops, integrated isolator, needs external power supply

GD102A

ADDRESSABLE PETROL STEAM CATALYTIC GAS DETECTOR, IP55, can be directly connected on HEPHAIS loops, integrated isolator, needs external power supply

GD104A

ADDRESSABLE HYDROGENE CATALYTIC GAS DETECTOR, H₂, IP55, can be directly connected on HEPHAIS loops, integrated isolator, needs external power supply

GD105A

ADDRESSABLE CATALYTIC LIQUID PETROLEUM GAS DETECTOR, LPG, IP55, can be directly connected on HEPHAIS loops, integrated isolator, needs external power supply

GD106A

ADDRESSABLE PROPANE CATALYTIC GAS DETECTOR, C₃H₈, IP55, can be directly connected on HEPHAIS loops, integrated isolator, needs external power supply

GD113A

ADDRESSABLE CARBON MONOXIDE GAS DETECTOR, CO, IP55, ELECTROCHEMICAL CELL, can be directly connected on HEPHAIS loops, integrated isolator, needs external power supply



GAS DETECTION

Accessories

MEGAS

METHANE GAS TEST BOTTLE , 40% L.I.E,
12 liters (to be used with P7150V)

COGAS

CARBON MONOXIDE GAS TEST BOTTLE,
250ppm, 12 liters (to be used with P7150V)

VPGAS

PETROL STEAM GAS TEST BOTTLE, 40% L.I.E,
12 liters (to be used with P7150V)

LPGGAS

LPG GAS TEST BOTTLE, 40% L.I.E, 12 liters
(to be used with P7150V)

HYGAS

HYDROGEN GAS TEST BOTTLE, 48% L.I.E,
12 liters (to be used with P7150V)



GDREL

PLUG-IN 3 RELAY CARD, NO-NC 30V/1A,
to be plugged inside the detector GDxxxC,
permits to repeat ALARM, PREALARM, FAULT
of the detector



DETTEL

REMOTE CONTROL WITH DISPLAY AND KEYPAD
for GAS DETECTORS, permits to read and set
the level and data of detectors (sensitivity,
thresholds...)



P7150V

TEST KIT GAS DETECTORS (valve + adapter)



GD-range GAS DETECTOR Conventional version



+



GDREL*

Available 3 relays:

- Pre Alarm
- Alarm
- Fault



DETTEL

For Settings configuration:

- Thresholds
- Filter delays

* Note that all detectors are equipped with 4/20mA output



EXPLOSION PROOF GAS DETECTION

Flammable gas

SD2243ME

Exd METHANE GAS DETECTOR, 0-100% LEL, Ex 2GD Ex d IIC T6 Ex tD A21 IP65 T 85°C

SD2243VB

Exd PETROL STEAM GAS DETECTOR, 0-100% LEL, Ex 2GD Ex d IIC T6 Ex tD A21 IP65 T 85°C

SD2243BU

Exd BUTANE GAS DETECTOR, 0-100% LEL, Ex 2GD Ex d IIC T6 Ex tD A21 IP65 T 85°C

SD2243PR

Exd PROPANE GAS DETECTOR, 0-100% LEL, Ex 2GD Ex d IIC T6 Ex tD A21 IP65 T 85°C

SD2243GP

Exd LPG GAS DETECTOR, 0-100% LEL, Ex 2GD Ex d IIC T6 Ex tD A21 IP65 T 85°C

SD2243H2

Exd HYDROGEN GAS DETECTOR, 0-100% LEL, Ex 2GD Ex d IIC T6 Ex tD A21 IP65, T 85°C

SD2244AM

Exd AMMONIAC GAS DETECTOR, 0-100% LEL, Ex 2GD Ex d IIC T6 Ex tD A21 IP65 T 85°C



Toxic gas

SD2245O2

Exd OXYGEN GAS DETECTOR, 0-25% vol, Ex 2GD Ex d IIC T6 IP65

SD2246AM

Exd AMMONIAC GAS DETECTOR, 0-200 ppm, Ex 2GD Ex d IIC T6 IP65

SD2247AM

Exd AMMONIAC GAS DETECTOR, 0-1000 ppm, Ex 2GD Ex d IIC T6 IP65

Infrared sensor

S2651CO2

Exd CARBON DIOXIDE GAS DETECTOR 2% Vol-Ex II 2G G-C2 IR IP65

Accessories



STS/CKD

Calibration keypad to adjust the detector zero and span values



ZMCAP

Calibration adapter



STS3REL

PLUG-IN 3 RELAY CARD, NO-NC 30V/1A , to be plugged inside the detector, permits to repeat ALARM, PREALARM, FAULT of the detector



FMGDS

PLUG-IN addressable loop powered module for SD Explosion proof gas detectors. Takes 2 addresses on the loop

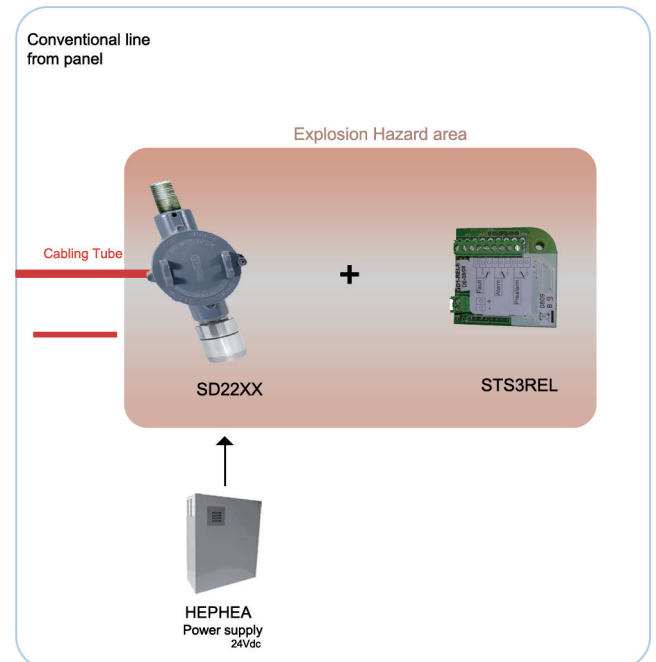
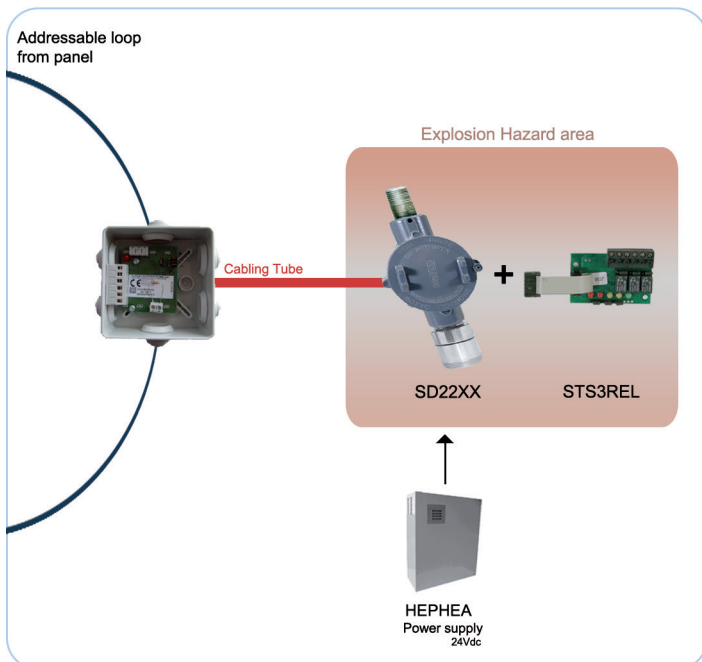



DEVICES FOR FIRE EVACUATION

IND05

REMOTE ALARM INDICATOR
angle of vision = 180°



IND05E

WATERPROOF REMOTE ALARM INDICATOR
angle of vision = 180°

IAA

REMOTE ALARM INDICATOR for more than one detector

AVS 2000/R

HIGH POWERED PIEZOELECTRIC SOUNDER for INDOOR use (red colour), possibility to select 6 tones, 95db@1m, lateral hearings, EN54-3, CE according to CPD/CPR, Exists also in white colour (AVS2000/W) (base included)

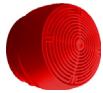

AVSU EFP

HIGH POWERED PIEZOELECTRIC SOUNDER for OUTDOOR, 114db@1m, IP65, CE according to CPD/CPR, EN54-3



DSF 2000-RR

CONVENTIONAL sounder + flash (red flash+red box); 3 different sounds, 97dB, low current consumption, IP21C, EN54-3, EN54-23, CE according to CPD/CPR (exist also in white flash), base included



DFD 2000-R1-RR

CONVENTIONAL LED FLASH (red flash+red box) for diffusion. 16-58Vdc, EN54-23, CE according to CPD/CPR (exist also in white flash)



Base 1,5

Base for DFD2000 (exist also in white)



8500x

COMBINED SOUNDER AND FLASH for OUTDOOR WALL MOUNTED (red colour), IP66, 100db@1m, EN54-3 according to CPD



531024-1019

XENON OUTDOOR BEACON high luminosity with 360° angle, from 9Vdc to 60Vcc, IP65



POA543-C

CONVENTIONAL OPTICAL ACOUSTIC ALARM PANEL WITH BUZZER lighting with high luminosity LED, low current consumption, 12V/24Vds, buzzer 94db@1m, IP55, CE according to CPD/CPR, EN54-3



POA543-I

ADRESSABLE OPTICAL ACOUSTIC ALARM PANEL WITH BUZZER lighting with high luminosity LED, low current consumption, 12V/24Vds, buzzer 94db@1m, IP55, CE according to CPD/CPR, EN54-3, EN54-17

P7540

IP65 kit dedicated to POA543 panels

3D MONITORING SOFTWARE

For 1 PANEL HEPHAIS 1600 or HEPHAIS 1600 NE and max 400 addresses

SD3 MAPSVIEW NE (400 addresses)
 3 DIMENSION BASE REMOTE MAP MONITORING SOFTWARE FOR MAX 400 addresses, compatible with HEPHAIS 1600 panels range. MAX 400 ADDRESSES MANAGED, NOT EXPANDABLE. Fully high level software (mails, CSV memory event, webaccess, statistics, autocad file import) including auto download sincronisation with the HEPHAIS 1600 panel. TCPIP management included (needs converted)

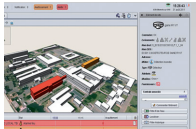

SD3 MAPSVIEW NE MUL PC
 MULTI PC integrating 1 station (Total 2 stations), 3 DIMENSION BASE REMOTE MAP MONITORING SOFTWARE FOR MAX 400 addresses, compatible with HEPHAIS 1600 panels range. MAX 400 ADDRESSES MANAGED , NOT EXPANDABLE. Fully high level software (mails, CSV memory event, webaccess, statistics, autocad file import) including auto download sincronisation with the HEPHAIS 1600 panel. TCPIP management included (needs converter)

For 1 PANEL HEPHAIS 1600 or HEPHAIS 1600 NE and illimited addresses

SD3 MAPSVIEW
 3 DIMENSION BASE REMOTE MAP MONITORING SOFTWARE FOR 1 complete PANEL compatible with HEPHAIS 1600 panels range. Possibility to be expanded. Fully high level software (mails, CSV memory event, webaccess, statistics, autocad file import) including auto download sincronisation with the HEPHAIS 1600 panel. TCPIP management included. (needs converted)



SD3 MAPSVIEW MUL PC
 MULTI PC integrating 1 station (Total 2 stations), 3 DIMENSION BASE REMOTE MAP MONITORING SOFTWARE FOR 1 complete PANEL, compatible with HEPHAIS 1600 panels range. Possibility to be expanded. Fully high level software (mails, CSV memory event, webaccess, statistics, autocad file import) including auto download sincronisation with the HEPHAIS 1600 panel. TCPIP management included (needs converter)

SD3 MAPSVIEW PLUS
 ADDITIONAL LICENSE for 1 panel management, compatible with addressable HEPHAIS 1600 panels and dedicated only for SD3 MAPSVIEW or SD3 MAPSVIEW NE

Options for SD3 MAPSVIEW and SD3 MAPSVIEW NE

- SD3 MAPSVIEW PLUS PC**
 ADDITIONAL LICENSE for 1 PC management, dedicated only for SD3 MAPSVIEW MUL PC or SD3 MAPSVIEW NE MUL PC
- SD3 MAPSVIEW BUILD**
 License for building plans on SD3 MAPSVIEW

OPC Server

SD3OPC
 OPC server for integrating equipment and application into SD3 system

CONVERTERS

Serial converter

- MA53**
 CONVERTER MODULE RS232/RS422 with power supply
- MB3180**
 Converter Serial MODBUS/TCPIP. RS-232, RS-422, 4-wire RS-485, and 2-wire RS-485 TO TCPIP CONVERTER MODULE with power supply. The DE-311 supports 10/100 Mbps Ethernet connections and has a DB9 female connector for the serial port



Optic fiber converter

- CONCUFI**
 CONVERTER MODULE RS422/RS485/RS232 to MULTIMODE optic fiber max distance 6km, rail din enclosure, 7Vdc to 60Vdc power
- CONCUFI SMODE**
 CONVERTER MODULE RS422/RS485/RS232 to SINGLE MODE optic fiber max distance 25km, rail din enclosure, 7Vdc to 60Vdc power





MONITORING SOFTWARE

3D online navigation

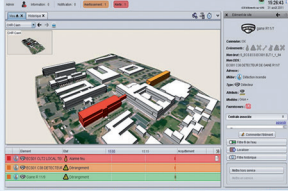

3D site modelisation

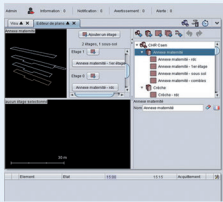

AUTOCAD files import



Real-time synchronisation Edit your database while you supervise your site



Real-time synchronisation with the panel database

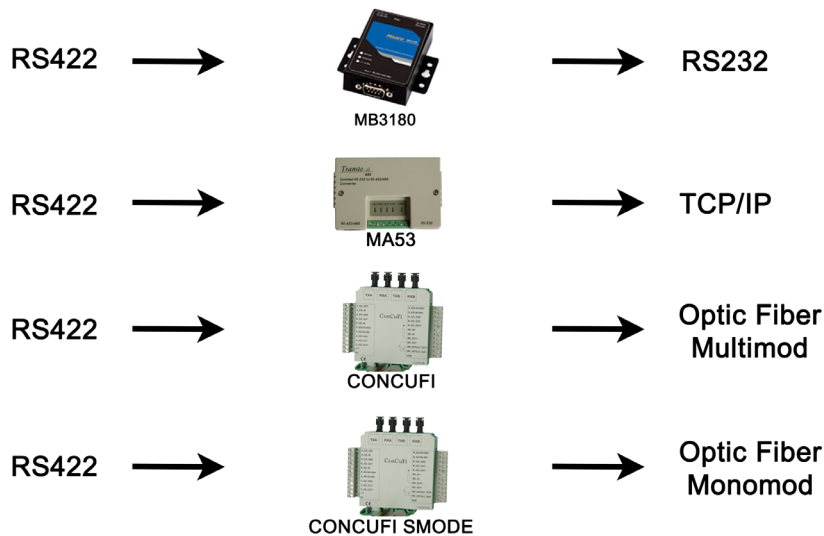
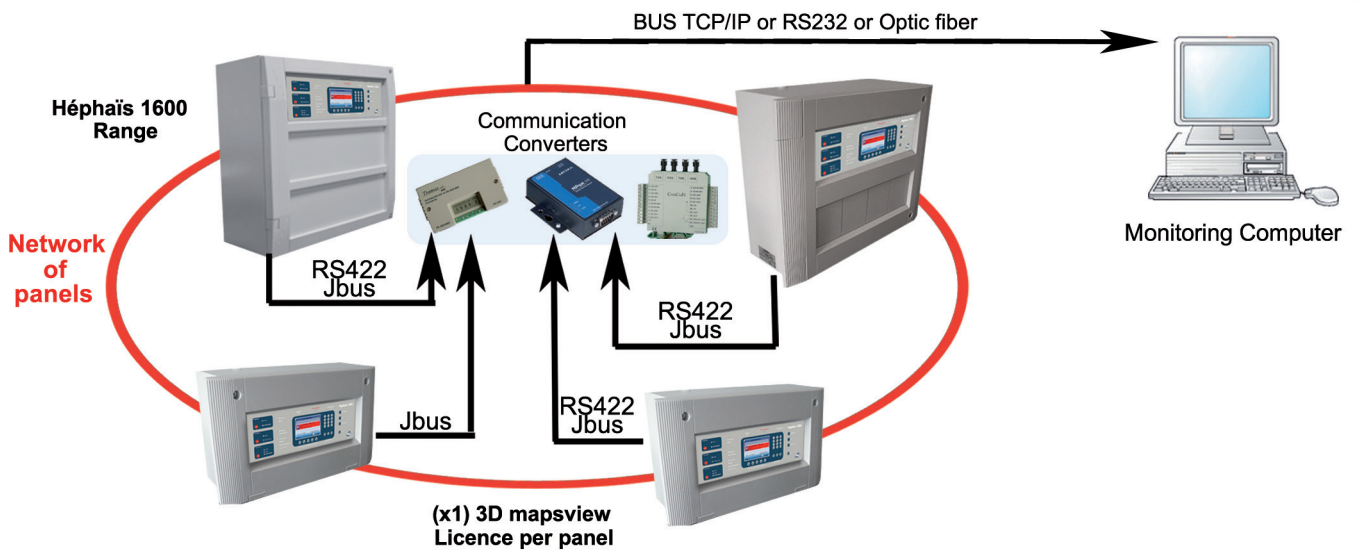



EXPLOSION HAZARD AREA FIRE DETECTION

Fire alarm devices



VIREX + SVEX

CONVENTIONAL INFRARED FLAME DETECTOR
Ex version, ATEX II 1G Eex ia IIC T6, EN54-10, CE
according to CPD/CPR, + base SVEX



OC05EX

CONVENTIONAL OPTICAL SMOKE DETECTOR
Ex version, ATEX II 1G Eex ia IIC T6 EN54-7, CE
according to CPD/CPR



TRC05EX

CONVENTIONAL RATE OF RISE + FIXED HEAT
DETECTOR, Ex version, ATEX II 1G Eex ia IIC
T6, EN54-5, CE according to CPD/CPR



S05EX

MOUNTING BASE- anti-static design Ex version



DMC05EX

TDMC05EX(front MCP) + FBBG2EX-R (Back box
MCP), CONVENTIONAL MANUAL CALL POINT with
reset key, Ex version, certified
ATEX 94/9/CE, CE certified, EN60079-0,
EN60079-11



ISMA1

INTRINSICALLY SAFE SOUNDER which produces a
loud warning signal in a hazardous area.



SBEX BZ1

SAFETY BARRIER dedicated for intrinsically safe
detectors and call points



SBEX BZ2

SAFETY BARRIER dedicated for intrinsically safe
detectors and call points, **opto-isolated**.
To be supplied when teh ex detectors are
not connected to SD³ panels

SBEX BZ3

SAFETY BARRIER dedicated exclusively for
intrinsically safe sounders

Addressable Ex interface



MBA95Ex

ADDRESSABLE ZONE INTRINSICALLY INTERFACE MODULE with backbox, for max 10 conventional EEX points, isolator
integrated, opto-isolated on the secondary line, EN54-17, EN54-18, CE according to CPD/CPR

Conventional Ex interface



ALPHA 4/8/12

12 ZONES FIRE DETECTION CONVENTIONAL
PANEL equipped with 4 zones (max 12 zones)
- max 32 detectors and/or MCP per line.
Alarm/fault relays, 1 monitored sounders line,
4 programmable open collectors,
1 programmable input. Alarm prealarm
management + Day night mode. Expandable
panel with availability of 2 rooms for one or two
4 zones expansion board (EX4A4 or EX4A4EX) or
one or two Extinguishing boards (DEAG). EN54-
2, EN54-4 AFNOR, BOSEC, CE according to
CPD/CPR, EN12094-1 with extinguishing board
(DEAG). Needs 2 batteries 12V/7Ah. Exists also in
110VAC version



EX4A4ex

4 ZONES EXPANSION BOARD Ex VERSION to be
used with explosion hazard area detectors, max
10 detectors per line, 1 or 2 EX4A4ex boardscan
be plugged in ALPHA 4/8/12



REP4R

4 WAYS RELAY CARD, NO-NC 30V/1A, to be
plugged inside the panel, connection by wires
with programmable open collectors of
ALPHA 4/8/12



R12P2

12 WAYS RELAY CARD, NO-NC 30V/1A, to
be plugged inside ALPHA 4/8/12 panel, serial
communication, permits to repeat states of the
panel on 12 relays



EXPLOSION HAZARD AREA FIRE DETECTION

Addressable Ex interface

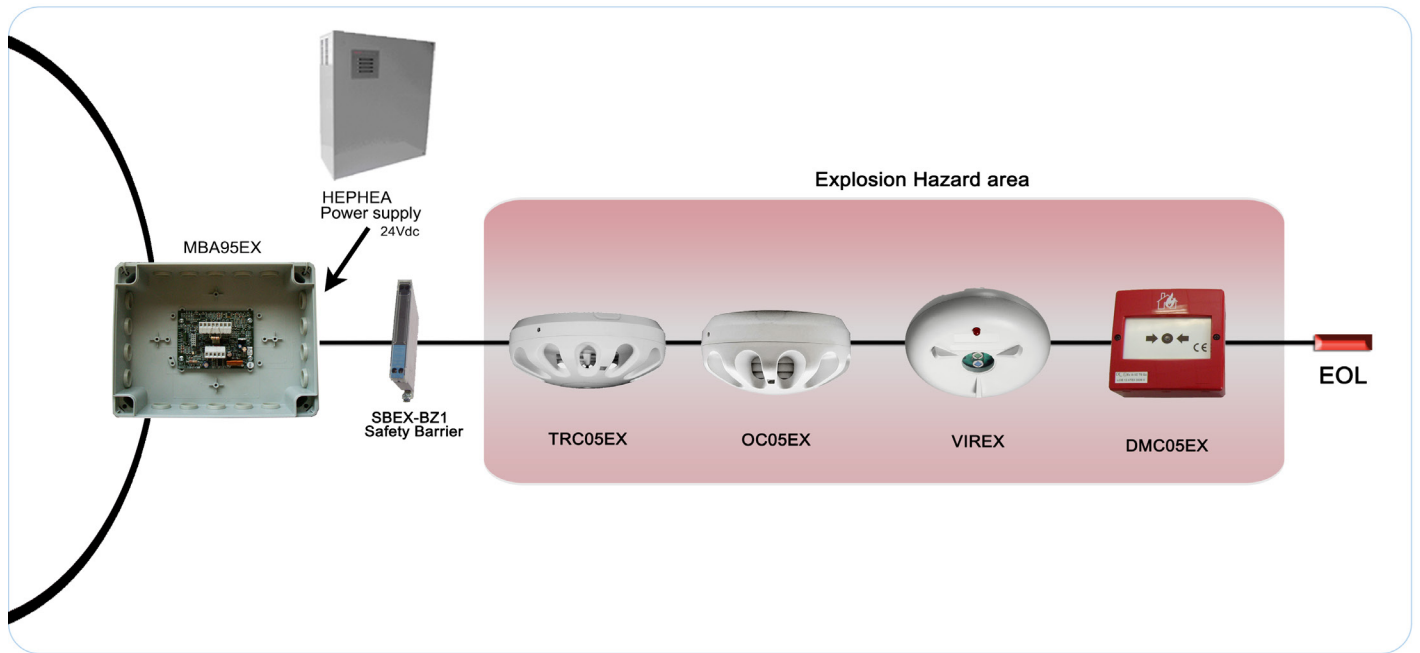

Conventional Ex interface

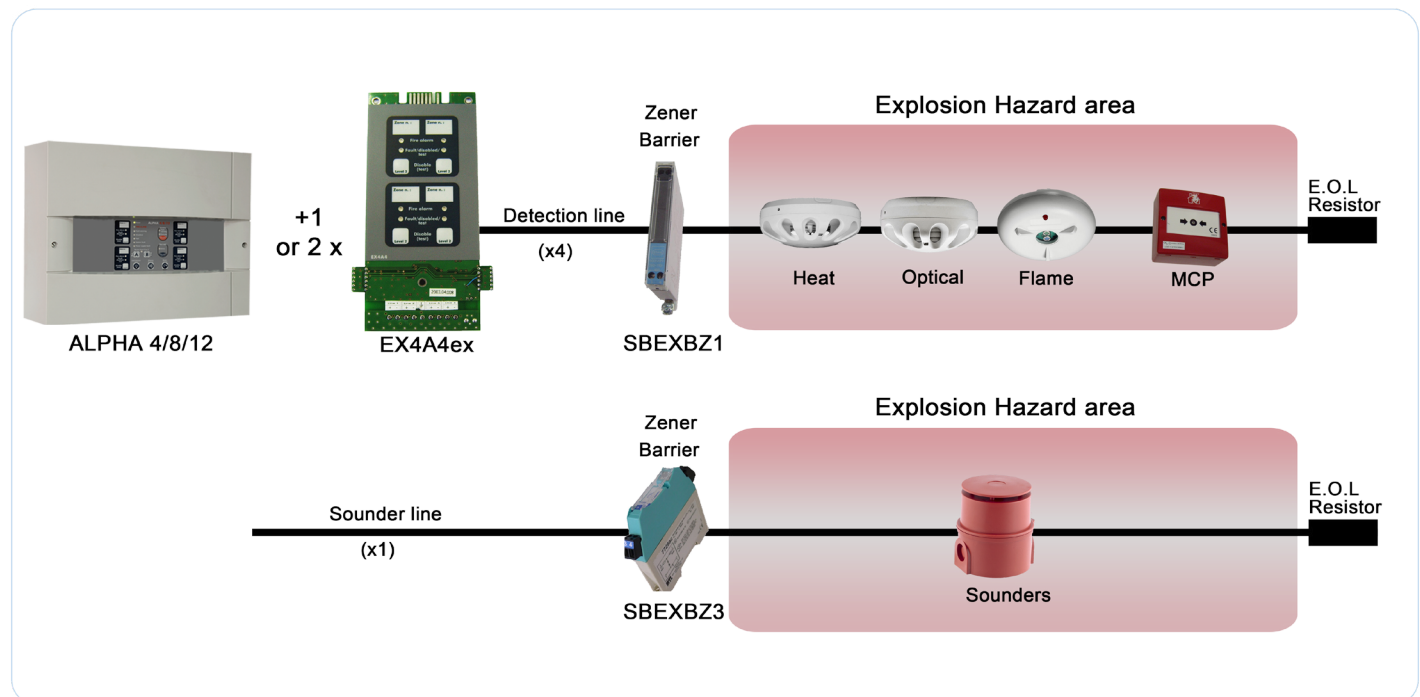

Explosion proof beam detector



DLFB30 R EX

EXPLOSION PROOF RELAY BEAM DETECTOR, for linear smoke detection supplied with reflector for distance from 3 up to 30 meters, NO-NC ALARM, NO-NC FAULT, integrated laser pointer for alignment, EN54-12, CE according to CPD/CPR, Ex II 2 G Ex d IIC T6, II 2 D Ex td A21 IP66 T85°C

EXTINGUISHING SYSTEMS

ALPHA 4/8/12



12 ZONES FIRE DETECTION CONVENTIONAL PANEL equipped with 4 zones (max 12 zones) - max 32 detectors and/or MCP per line. Alarm/fault relays, 1 monitored sounders line, 4 programmable open collectors, 1 programmable input. Alarm prealarm/management + Day night mode. Expandable panel with availability of 2 rooms for one or two 4 zones expansion board (EX4A4) or one or two Extinguishing boards (DEAG). EN54-2, EN54-4 AFNOR, BOSEC, CE according to CPD/CPR, EN12094-1 with extinguishing board (DEAG). Needs 2 batteries 12V/7Ah. Exists also in 110VAC version

Options

Accessories



DEAG
1 ZONE EXTINGUISHING EXPANSION BOARD, to be used for management of 1 extinguishing channel. All monitored lines : Extinguishing actuators, Evacuation panels, Release button, Abord button, Low pressure contact. This board permits to convert ALPHA 4/8/12 panel in a detection extinguishing panel. CE CPD, EN12094-1



R4P2
4 WAYS RELAY CARD, NO-NC 30V/1A, to be plugged inside the panel, **serial communication**, permits to repeat states of the panel on 4 relays



R12P2
12 WAYS RELAY CARD, NO-NC 30V/1A, to be plugged inside ALPHA 4/8/12 panel, **serial communication**, permits to repeat states of the panel on 12 relays



62116014
Selector valve (DN50)

62116012
Selector valve CE 350 bars 1"1/4 (DN32)

62116013
Selector valve CE 350 bars 1"1/2(DN40)

62116011
Selector valve CE 350 bars 1" (DN25)



6050324N
Pneumatic siren



BS36015
Silent nozzle 360° 1/2FG

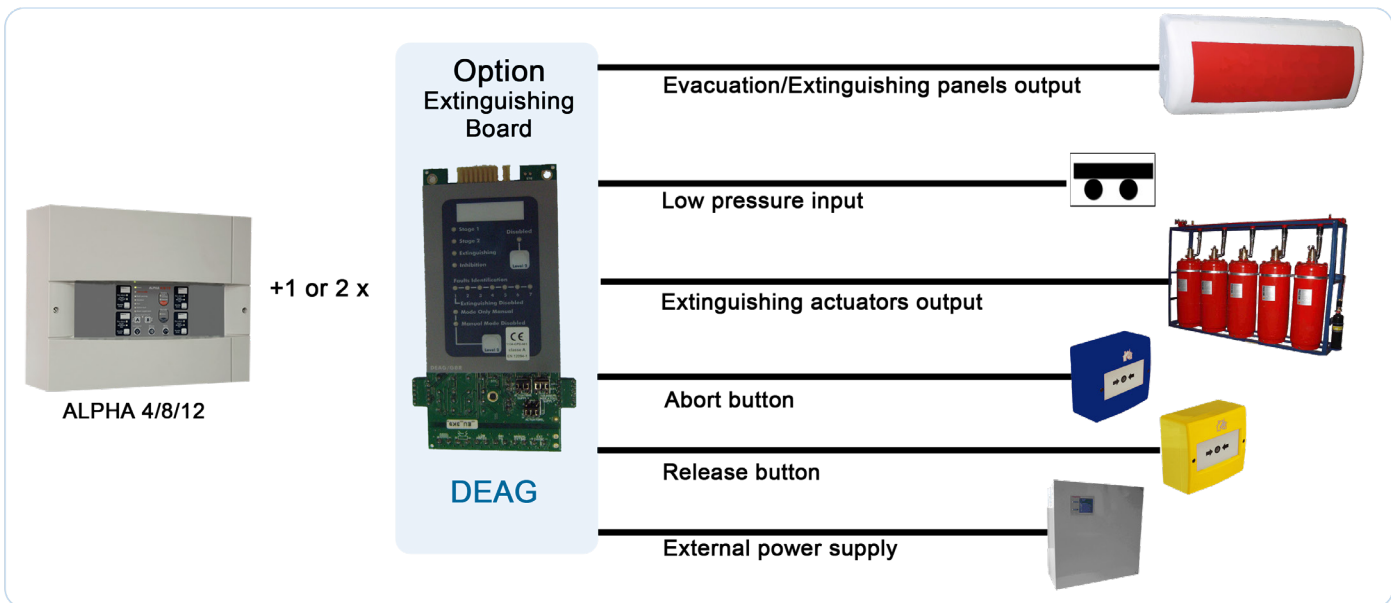



CONVENTIONAL PANEL

ALPHA 4/8/12 - M



12 ZONES FIRE DETECTION CONVENTIONAL PANEL equipped with 4 zones (max 12 zones) - max 32 detectors and/or MCP per line. Alarm/fault relays, 1 monitored sounders line, 4 programmable open collectors, 1 programmable input. Alarm prealarm/management + Day night mode. Expandable panel with availability of 2 rooms for one or two 4 zones expansion board (EX4A4) or one or two Extinguishing boards (DEAG). EN54-2, EN54-4 AFNOR, BOSEC, CE CPD, EN12094-1 with extinguishing board (DEAG). CE Med marine Bureau Veritas approved. Needs 2 batteries 12V/7Ah

CONVENTIONAL DETECTORS AND MCP



OC05-M

CONVENTIONAL OPTICAL SMOKE DETECTOR,
1 remote led output, EN54-7, CE according to CPD, CE Med marine Bureau Veritas approved



TRC05-M

CONVENTIONAL RATE OF RISE + FIXED HEAT DETECTOR,
T° =62°C, +9°C/min, 1 remote led output, EN54-5, CE according to CPD, CE Med marine Bureau Veritas approved



TSC05-A1S-M

CONVENTIONAL FIXED HEAT DETECTOR
T° =62°C, 1 remote led output, EN54-5, CE according to CPD, CE Med marine Bureau Veritas approved



DMCL05-M

MANUAL CALL POINT
resettable with key without breaking glass, red colour,
EN54-11, CE Med marine Bureau Veritas approved



IRY2+S95-M

CONVENTIONAL INFRARED FLAME DETECTOR,
1 remote led output, vision cone ± 45°, Distance max 25m, EN54-10 class 1 and 2, CE according to CPD, CE Med marine Bureau Veritas approved,base included

Bases



BRI+S05SE

WATERPROOF universal base with glands for 05 range (IP65), base with tubes connections supplied with glands



S05SE

UNIVERSAL BASE WITH STICK ADDRESS SOCKET for 05-range conventional and addressable detectors



ACCESSORIES FOR FIRE ALARM SYSTEM

MAGNET



VTR0241210

ELECTROMAGNETIC DOOR release unit in metal case, 50daN, 24V



V7RSSOL

Floor support for magnet VTR0241210 (option)

CONVERTER

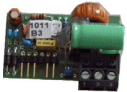

RT/B

Converter Module 24Vdc to 12 Vdc.



USB/232

CONVERTER MODULE USB/232



HEPHEA RANGE POWER SUPPLY



PSUC224S

Wall mounting 24Vdc safety power supply unit, 2,5A version.

Delivered in metallic enclosure able to house batteries with capacity up to 17Ah. (Also available in rack version)



PSUC524S

Wall mounting, 24Vdc safety power supply unit, 2,5A version.

Delivered in metallic enclosure able to house batteries with capacity up to 17Ah. (Also available in rack version)



PSUC54M

Wall mounting, 24Vdc safety power supply unit, 2,5A version.

Delivered in metallic enclosure able to house batteries with capacity up to 17Ah. (Also available in rack version)



HEPHEA 248B

Power supply box designed to be appropriate for the use as a power unit with a reserve of energy for the supply of a fire detection installation in accordance with the Directive of the Products of

Construction CPD 89/106/CEE. The electric and mechanical realization of these products is in conformity with the EN standards 54-4:1997 + A1:2002 + A2:2006, EN12101-10 and EN60950-1:2001.

RACK VERSION



HEPHEA 248B/R

Power supply box in RACK version designed to be appropriate for the use as a power unit with a reserve of energy for the supply of a fire detection installation in accordance with the Directive of the Products of

Construction CPD 89/106/CEE. The electric and mechanical realization of these products is in conformity with the EN standards 54-4:1997 + A1:2002 + A2:2006, EN12101-10 and EN60950-1:2001.



VOICE EVACUATION SYSTEMS

COMPACT PANEL - 1 Zone - 2x12 speakers



SEV4

VOICE EVACUATION CENTRAL PANEL, manages 2 speakers monitored lines with max 12 speakers per line, connected to monitored sounder line or relay contact, needs 230Vac main supply . Metallic box. **Certified EN54-16 CE according to CPD/CPR**

SPEAKERS



VES2

Flush mounted ceiling speaker, 1,5W, max 100m², EN54-24, CE according to CPD/CPR



SAFE2

Wall speaker, 1,5W, max 200m², EN54-24, CE according to CPD/CPR



RB

Sound projector speaker, 2,5W, outside under ceiling, EN54-24, CE according to CPD/CPR

LBC

Sound projector speaker, 6W, outside IP65, EN54-24, CE according to CPD/CPR

Amplifier and Microphone



KITMICRO

Microphone console supplied with Din cable + amplifier board accessories



PR1106

Preamplifier, 6 outputs, with 4 universal inputs Micro/Aux

COMPACT PANEL- 4 broadcasting zones- 1 alarm zone up to 400W

VULCAVOICE 1L

Stand alone VACIE, EN54-16 and EN54-4 certified, CE according to CPD/CPR. 2 AUX inputs, 1 microphone, 1 message data base, 1 loudspeaker lines, 300W Max, Integrated UPS

VULCAVOICE 2L

Stand alone VACIE, EN54-16 and EN54-4 certified, CE according to CPD/CPR, 2 AUX inputs, 1 microphone, 1 message data base, 2 loudspeaker lines, 400W Max, Integrated UPS

VULCAVOICE 3L

Stand alone VACIE, EN54-16 and EN54-4 certified, CE according to CPD/CPR. 2 AUX inputs, 1 microphone, 1 message data base, 3 loudspeaker lines, 400W Max, Integrated UPS

VULCAVOICE 4L

Stand alone VACIE, EN54-16 and EN54-4 certified? CE according to CPD/CPR. 2 AUX inputs, 1 microphone, 1 message data base, 4 loudspeaker lines, 400W Max, Integrated UPS



SPEAKERS



RB-6501-EN54

Ceiling Loudspeaker 100V-10W EN54-24, CE according to CPD/CPR



VOICE15T-EN5424

Horn loudspeaker 15W - 100V - 110dBmax/1W/1m - EN54-24, CE according to CPD/CPR



KM180T-EN5424

Hanging loudspeaker (small) - 10W - 100V - 92dBmax/1W/1m - EN54-24, CE according to CPD/CPR



ZR-1110

100V volume controller - 10W - level restoration relay

Microphone



GX3016

1-16 zones + all microphone console - daisy chain connection 24Vdc - RS 485 bus



VOICE EVACUATION SYSTEMS

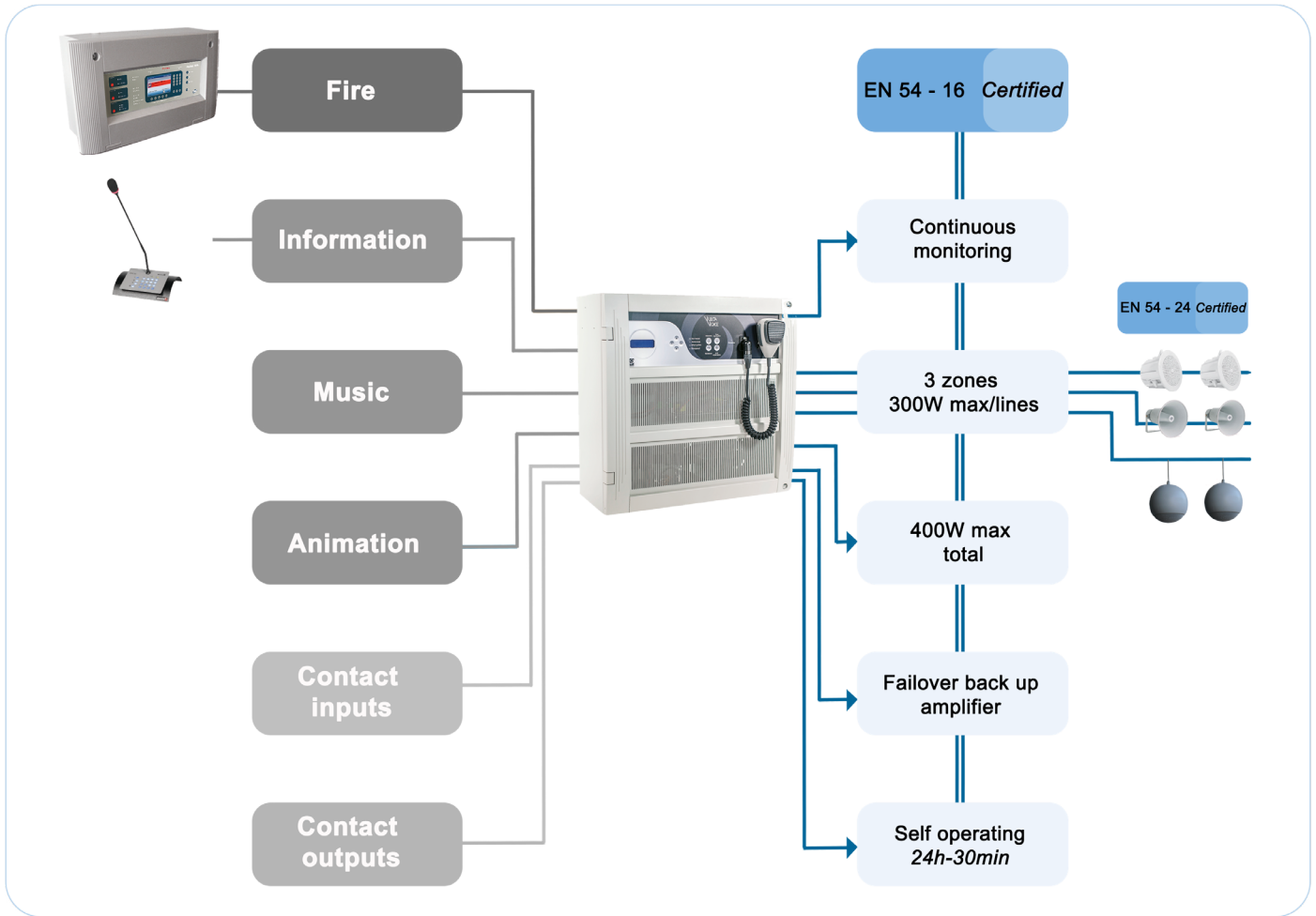

ELECTRIC LOCK FOR EMERGENCY EXIT DOORS



DS3000

ELECTRIC LOCK FOR EMERGENCY exit doors with one leaf

9055469

Holds in PVC of 25mm for DS3000



CLEVA2-CLE

LOCAL COMMAND of evacuation with key including delay of closing



BBG-V

Green Manual Call point with reset key



FIRE ALARM CABLE

SAS0210HFEEH-F3FG4

2x1,00 mm² cable, twisted with screen, polyvinylchloride rated, flame retardant, (rolls by 200m), EN50200



SAS0215HFEEH-F3FG4

2x1,5 mm² cable, twisted with screen, polyvinylchloride rated, flame retardant, (rolls by 200m), EN50200

SAS0225HFEEH-F3FG4

2x2,5 mm² cable, twisted with screen, polyvinylchloride rated, flame retardant, (rolls by 200m), EN50200



MAINTENANCE AND TEST EQUIPMENT

Cleaning tool



CLEANING TOOL

Tool kit dedicated to the maintenance of optical sensors

Test flame detector tool



BT-DF

Tool Tester with battery charger for flame detectors IR and UV

Test and mounting tools



3010

Smoke detector tester



3015

Aerosol bottle of 250 ml (pack of 12)



3053

Heat detector tester (head and 12V controller)



3059

12V charger

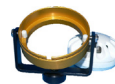

4065

05 removal tool



4051

95 removal tool

Telescopic access



2001

Telescopic access pole 2x1.50m

2002

Telescopic access pole 2x2.00m

Accessories

1001

1.00m extension

1004

1.50m extension

1005

2.00m extension



MAINTENANCE AND TEST EQUIPMENT

SPARE PARTS

Alpha 2

AL2BOARD

ALPHA 2 MOTHER BOARD

Alpha 4/8/12

AR4D

ALPHA 4/8/12 MOTHER BOARD

Hephaïstos 128

MP128

HEPHAÏSTOS 128 MOTHER BOARD

Hephaïstos 1600

RF H 1600

USER INTERFACE FRONT PANEL with alphanumeric display 160 characters and keyboard, 19 inches, 3U

MB2B

Panel's main CPU board

Hephaïstos 1600 NE

RF H 1600

USER INTERFACE FRONT PANEL with alphanumeric display 160 characters and keyboard, 19 inches, 3U

MB2B NE

Panel's main CPU board

ALBA150

Power supply for hephaïstos 1600

Head sensor gas detectors

W4187

HEAD GAS SENSOR for METHANE GAS DETECTOR GD100C or GD100A

W4186

HEAD GAS SENSOR for CO GAS DETECTOR GD103C or GD103A

W4188

HEAD GAS SENSOR for PETROL STEAM GAS DETECTOR GD102C or GD102A

W4189

HEAD GAS SENSOR for LIQUID PROPANE GAS DETECTOR LPG GD105C, GD106C or GD105A, GD106A

W4280

HEAD GAS SENSOR for CO GAS DETECTOR GD113C or GD113A

Alpha 500/1000

CPUB

CPU board for alpha 500/1000

ALBA

POWER supply for ALPHA 500/1000

MD1B05

Extension module for 4 spur circuits (max 32 points per circuit) or 2 loops (max 125 points), for 05 intelligent detectors range

MD1B

Extension module for 4 spur circuits (max 32 points per circuit) or 2 loops (max 125 points)

ESAL D 3U

User interface panel with alphanumeric display 160 characters and keyboard, rack mount version 19", for ALPHA 500/1000

95 serie detectors

OA95

Analogue/addressable optical smoke detector, EN54-7

TVA95

Analogue/addressable rate of rise + fixed heat detector, EN54-5, EN54-9

TPA95

Analogue/addressable fixed heat detector, EN54-5, EN54-9

OTA95

Analogue/addressable multicriteria (optical-heat) detector EN54-7, EN54-9

S95

Universal base for conventional and analogue detectors

W4088

HEAD GAS SENSOR for HYDROGENE GAS DETECTOR GD104C or GD104A

W4316

HEAD GAS SENSOR for HYDROGENE GAS DETECTOR catalytic GD104C-CT or GD104A-CT

W4315-CH4

HEAD GAS SENSOR for METHANE GAS DETECTOR catalytic GD100C-CT or GD100A-CT

W4315-VB

HEAD GAS SENSOR for PETROL STEAM GAS DETECTOR catalytic GD102C-CT or GD102A-CT

W4315-C3H8

HEAD GAS SENSOR for LIQUID PROPANE GAS DETECTOR LPG catalytic GD105C-CT, GD106C-CT or GD105A-CT, GD106A-CT

W4315-C4H10

HEAD GAS SENSOR for BUTHANE GAS DETECTOR catalytic GD101C-CT or GD101A-CT



NOTE

A series of horizontal dotted lines spanning the width of the page, intended for taking notes.



A world of fire detection equipment



Local Dealer

Follow us on LinkedIn



Non contractual document - 2021 - A

www.sd3.fr

41, rue du Saule Trapu
ZA du moulin de Massy
91300 Massy
FRANCE

Part of DEF Network



Company network of fire safety experts

www.def-network.com